

# MANUAL DE MONTAGEM

## INSTRUCCIONES DE MONTAJE

### ASSEMBLY INSTRUCTIONS

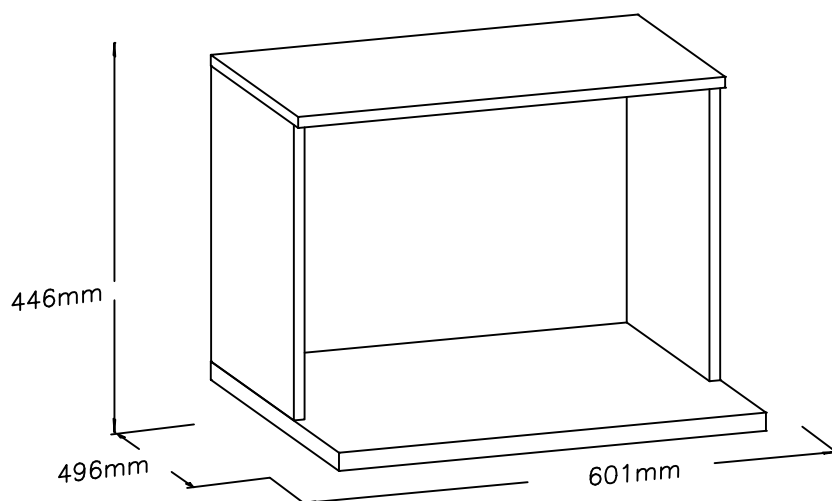

## ATENÇÃO / PRECAUCIÓN / ATTENTION:

- 1 – Ler atentamente todo o manual antes de iniciar a montagem do móvel.
- 2 – A montagem deve ser feita em uma superfície plana e limpa.
- 3 – Recomenda-se utilizar a embalagem do móvel para forrar e chão e assim não danificá-lo.
  - 1 – Lea cuidadosamente todo el manual antes de comenzar el montaje.
  - 2 – La instalación debe hacerse sobre una superficie plana y limpia.
  - 3 – Recomanda ser utilizado para empaquetar móvel a la línea y tierra y por lo tanto dañar ellos.
- 1 – Read the entire manual carefully before starting the furniture assembly.
- 2 – The assembly must be done on a flat and clean surface.
- 3 – It is recommended to use the packaging of the furniture to cover and floor and thus not to damage them.

## LIMPEZA E CONSERVAÇÃO / LIMPIEZA Y CONSERVACIÓN / CLEANLINESS AND CONSERVATION:

A limpeza do móvel deve ser feita com utilização de pano umedecido com água, podendo conter uma pequena quantidade de álcool. Não utilize produtos abrasivos.

La unidad de limpieza se debe realizar con el uso de paño humedecido con agua y puede contener una pequeña cantidad de alcohol. No utilice productos abrasivos.

The furniture should be cleaned with a cloth dampened with water and may contain a small amount of alcohol. Do not use abrasive products.

## GARANTIA / GARANTÍA / WARRANTY:

90 dias para defeitos de fabricação.

90 días a defectos de fabricación.

90 days for manufacturing defects.

## FERRAMENTAS NECESSÁRIAS / HERRAMIENTAS NECESARIAS / TOOLS REQUIRED:

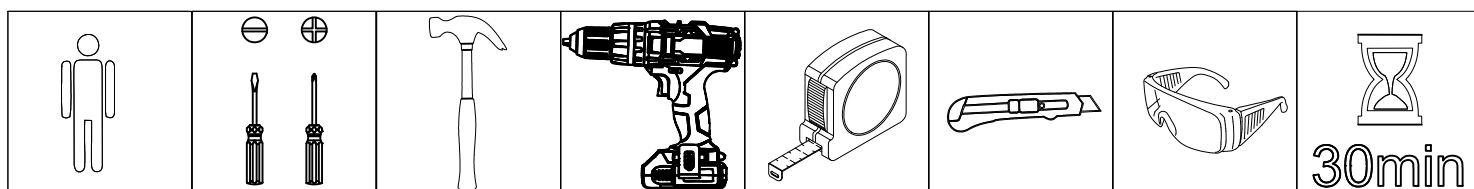

Acesse as dicas de  
montagem no Youtube

Accede a los consejos de  
montaje en Youtube.

Access the mounting tips on  
Youtube.

[www.youtube.com/MoveisKappesberg](http://www.youtube.com/MoveisKappesberg)







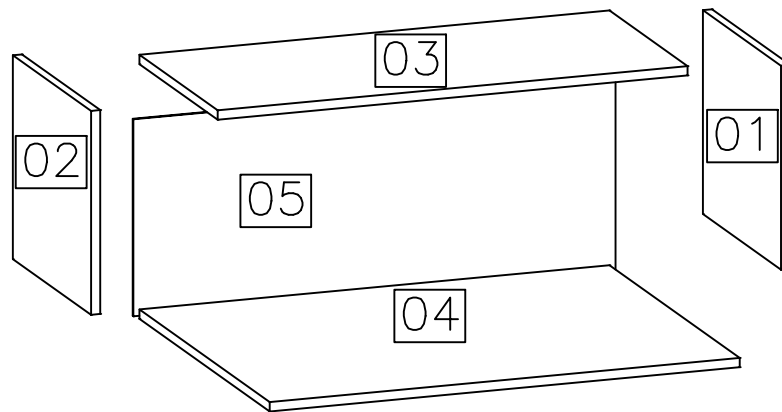



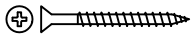

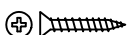
## Lista de peças / Lista de piezas / List of pieces

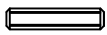
Código/ Código/ Code	Descrição	Descripción	Description	Quantidade/ Cantidad/ Amount	Comprimento/ Longitud/ Length (mm)	Largura/ Ancho/ Width (mm)	Espessura/ Espesor/ Thickness (mm)	Caixa/ Caja/ Box
01	Lateral direita	Lateral derecha	Right side	1	421	352	15	A
02	Lateral esquerda	Lateral izquierda	Left side	1	421	352	15	A
03	Chapéu	Pieza de techo	Top	1	570	352	15	A
04	Base	Pieza de suelo	Base	1	601	496	25	A
05	Costa	Pieza del fondo	Back panel	1	590	425	3	A

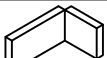

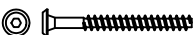
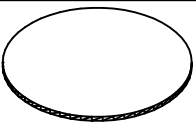
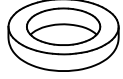
## Ferragem / Herrajes / Hardware

	Código/ Código/ Code	Descrição / Descripción / Description	Quan. / Cant. / Amou.
A	226	 Parafuso/ Tornillo/ Screw 4x40	4
B	4214	 Parafuso/ Tornillo/ Screw 3,5x14	4
C	50311	 Parafuso/ Tornillo/ Screw 5,0x65	2
D	491	 Parafuso/ Tornillo/ Screw 4x25	4
E	107	 Pregos/Clavo/Nail 10x10	20
F	1802	 Cavilha/Tarugo/Peg 6x30mm	4
G	17024	 Suporte aéreo zb/Soporte de seguridad/Safety bracket	2
H	6959	 Capa para suporte branca/Cubierta de soporte/Support cover	2
I	529	 Bucha invasiva/Adapter sleeve/ Manga del adaptador	2
K	1260	 Parafuso estrutural/ Tornillo estrutural/ Structural screw 7x70	4
L	<b>NO= 40736 (Nogal) AM= 36059 (Amendoa) BR=8010 (Branco)</b>	 Tapa furo/Tapa del agujero/Tap hole 13mm	4
M	14978	 Tampa CPL/ Tapa CPL/ CPL cover Carvalle 13mm	4
O	248	 Chave Allen/ Llave Allen/ Allen key 1/4"	1
01 Saco pequeno para acessórios			



