

# kappesberg

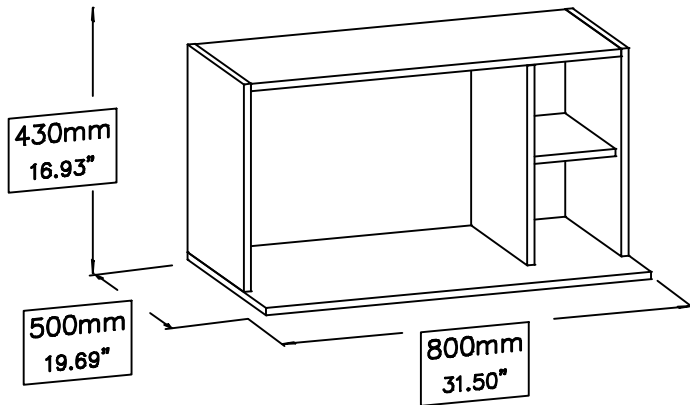

A montagem deve ser efetuada por UMA pessoa.  
El montaje debe ser efectuado por UNA persona.  
The assembly must be done by ONE people.

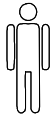

Ferramentas necessárias para montar o móvel  
Herramientas necesarias para armar el mueble.  
Tools needed to assemble the furniture.

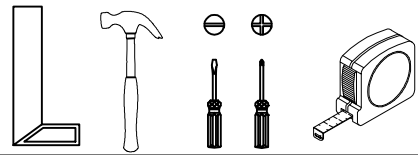

Montar o móvel sobre uma superfície limpa e plana  
Armar el mueble sobre una superficie limpia y plana  
Assemble the furniture on a clean and flat surface

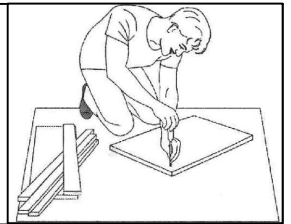

Lista de peças / Lista de piezas / List of pieces

Código / Code	Descrição	Descripción	Description	Quantidade / Cantidad / Amount	Comprimento / Longitud / Length (mm)	Comprimento / Longitud / Length (In.)	Largura / Ancho / Width (mm)	Largura / Ancho / Width (In.)	Espessura / Espesor / Thickness (mm)	Espessura / Espesor / Thickness (In.)	Caixa / Caja / Box
01	Lateral direita	Lateral derecha	Right side	1	400	15.75"	320	12.60"	15	.59"	A
02	Lateral esquerda	Lateral izquierda	Left side	1	400	15.75"	320	12.60"	15	.59"	A
03	Divisória	División	Division	1	400	15.75"	320	12.60"	15	.59"	A
04	Prateleiras	Estanterías	Shelf	1	320	12.60"	185	7.28"	15	.59"	A
05	Base	Pieza de suelo	Base	1	800	31.50"	496	19.53"	15	.59"	A
06	Chapéu	Pieza de techo	Top	1	800	31.50"	338	13.31"	15	.59"	A
07	Costa	Pieza del fondo	Back panel	1	790	31.10"	420	16.54"	3	.12"	A

**IDENTIFICAÇÃO DAS PEÇAS/ IDENTIFICACIÓN DE LAS PIEZAS/ PARTS IDENTIFICATION**

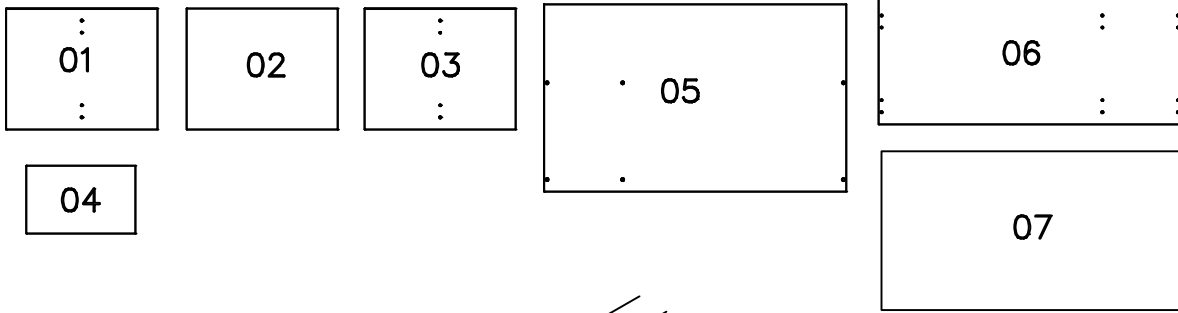

Duvidas? entrar em contato:  
¿Dudas? Ponerse en contacto:  
Doubts? Get In touch:

Fone: (51) 3635-8839  
www.kappesberg.com.br

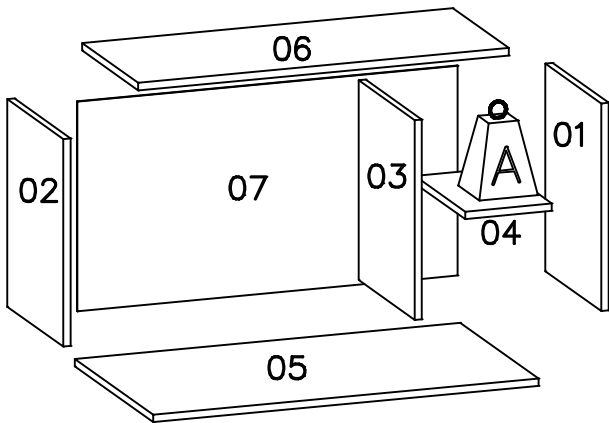
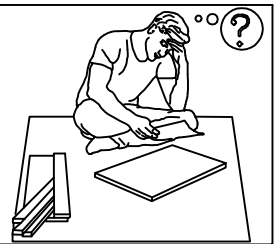

	Kg	lb
A	7	15.43lb

Em caso de dúvida, compare as ferragens com as imagens no decorrer do manual.

En caso de duda, compare el hardware con las imágenes del manual.

If in doubt, compare the hardware with the images throughout the manual

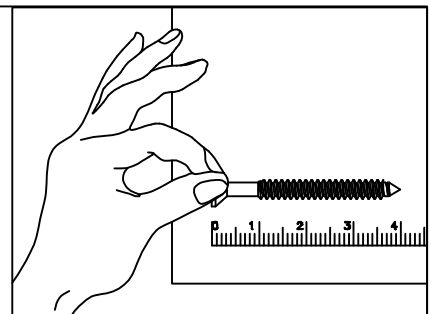

**IDENTIFICAÇÃO DOS ACESSÓRIOS/ IDENTIFICACIÓN DE ACCESORIOS/ IDENTIFICATION OF ACCESSORIES**





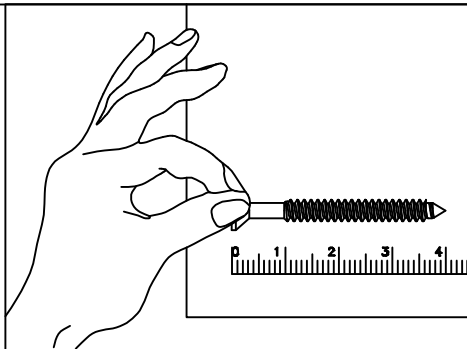

–NOTAS: A separação dos acessórios antes de iniciar a montagem facilitará a mesma. Os parafusos e cavilhas estão na escala real. Em caso de dúvida na identificação, coloque o acessório sobre a imagem.

–NOTAS:La separación de los accesorios antes de comenzar el armado facilitará el mismo. Los tornillos y taquetes son en escala real. En caso de dudas sobre la identificación, coloque el accesorio en la imagen.

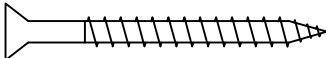
–NOTES:The separation of the accessories before you start the assembly will facilitate the same. The screws and dowels are in real scale. In case of doubts about the identification, place the accessory on the image

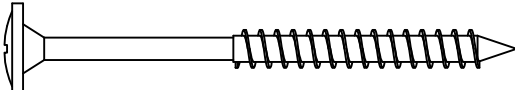
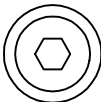
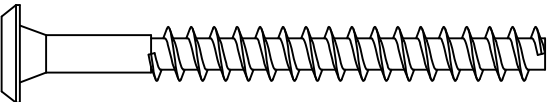

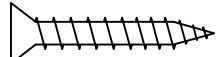
**Ferragem / Herrajes / Hardware**

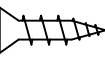
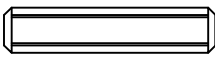
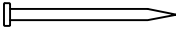
	Código/ Código/ Code	Descrição / Descripción / Description	Quan./ Cant./ Amou.
PC8	226	 	Parafuso chato/ Tornillo de cabeza plana/ Flat head screw 4x40mm <b>10</b>
PF9	50311	 	Parafuso flangeado/ Tornillo de cabeza flangead/ Flanged head screw 5,0x65mm <b>2</b>
PE11	167	 	Parafuso estrutural/ Tornillo estrutural/Structural screw 7x50 <b>6</b>
PC4	54117	 	Parafuso chato/ Tornillo de cabeza plana/ Flat head screw 3,5x25mm <b>2</b>
PC3	4214	 	Parafuso chato/ Tornillo de cabeza plana/ Flat head screw 3,5x14mm <b>4</b>
C1	1802		Cavilha/ Pin/ Wooden Dowel 6x30mm <b>10</b>
PR1	107		Prego/Clavo/Nail 10x10mm <b>24</b>

**Prezado Montador:**

- Antes de iniciar a montagem verifique as condições do ambiente de montagem;
- Confira todas as peças das embalagens com a lista de peças contida neste manual;
- Separe os acessórios, confira as medidas dos parafusos com a escala;
- Siga todas as orientações deste manual de montagem para ter o direito à garantia do produto;
- Descarte as embalagens de forma correta, destinando o plástico e o papel para reciclagem;





**Estimado Montador:**

- Antes de iniciar a montagem verifique as condições do ambiente de montagem;
- Confira todas as peças das embalagens com a lista de peças contida neste manual;
- Separe os acessórios, confira as medidas dos parafusos com a escala;
- Siga todas las orientaciones deste manual de montaje para ter o derecho à garantía do producto;
- Descarte como embalagens de forma correcta, destinando o plástico e o papel para reciclagem;

**Dear Fitter:**

- Before starting montagem check as conditions of the assembly environment;
- Check out all the packaging com a list of fish contained in this manual;
- Separate the accessories, check the measures two parafusos com to scale;
- Follow all the guidelines of this manual montagem for ter or direct to guarantee of the product;
- Discard the packages correctly, allocating either plastic or paper for recycling;

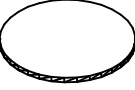
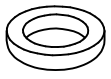

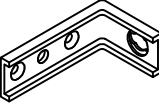
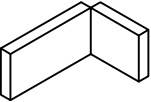
Ferragem / Herrajes / Hardware			
	Código/ Código/ Code	Descrição / Descripción / Description	Quan./ Cant./ Amou.
CB	41	 Cola branca em bispnaga/Cola blanca/White glue	1
BC	529	 Bucha invasa/Adapter sleeve/ Manga del adaptador	2
EM	58	 Etiqueta marca/Tag label "Kappesberg"	1
TP2	NG=63102 (Nogueira)	 Tapa furo/Tapa del agujero/Screw cap cover 13mm	10
CPL	NG=14978 (Carvalle)	 Tampa CPL/ Tapa CPL/ CPL cover 13mm	6
CZ1	248	 Chave Allen/ Llave Allen/ Allen key 1/4"	1
S10	17024	 Suporte aéreo/Soporte de seguridad/Safety bracket	2
CS	6959	 Capa para suporte /Cubierta de soporte/Support cover	2



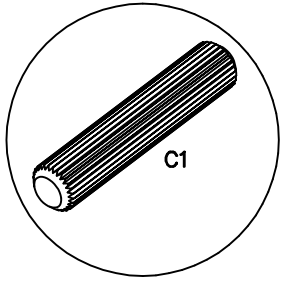
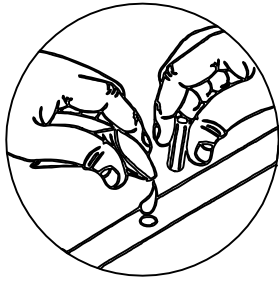
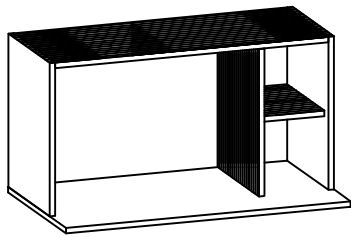
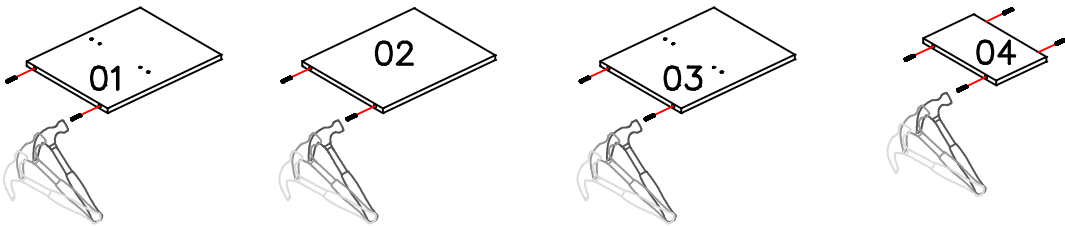

01 PASSO/ PASO/ STEP

C1		10
----	---	----

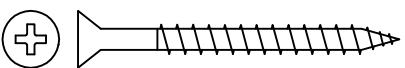

02 PASSO/ PASO/ STEP

PC8		4
TP2		4

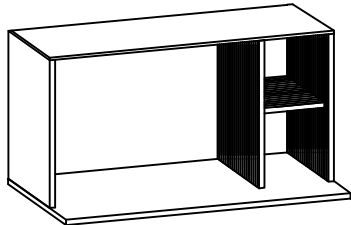
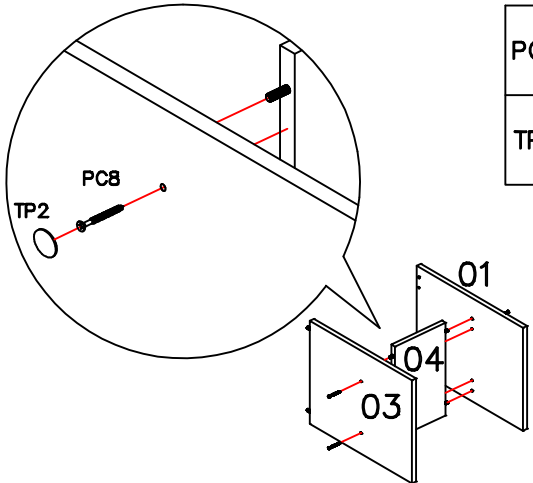

03 PASSO/ PASO/ STEP

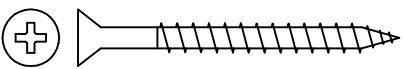
PC8		6
-----	---	---

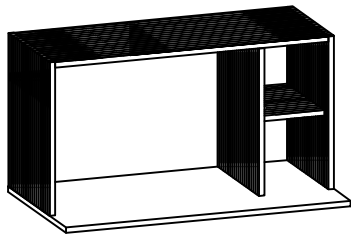
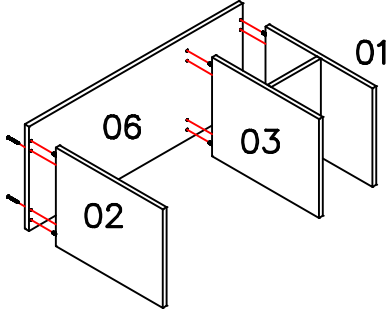
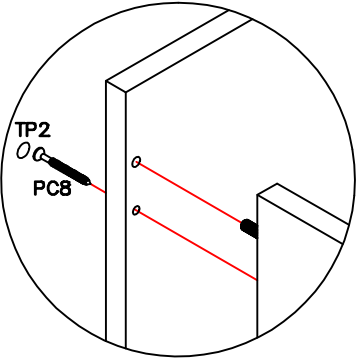

04 PASSO/ PASO/ STEP

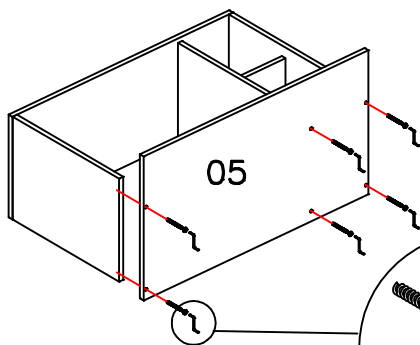
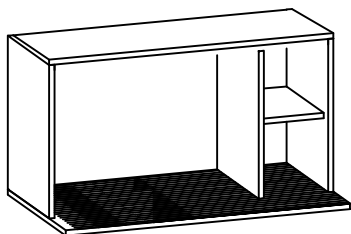

PE11		6
CZ1		1
CPL		6

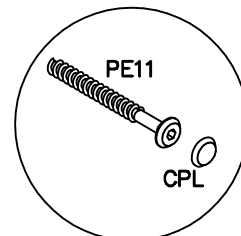
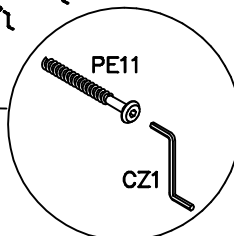

05 PASSO/ PASO/ STEP

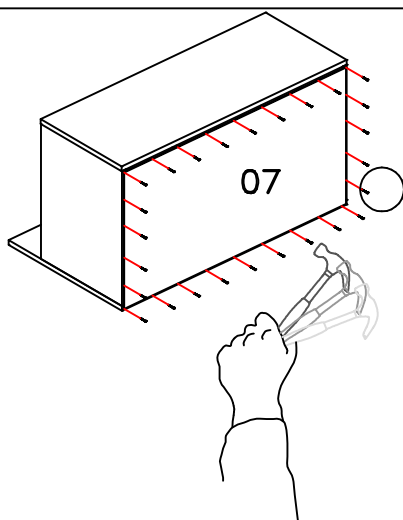
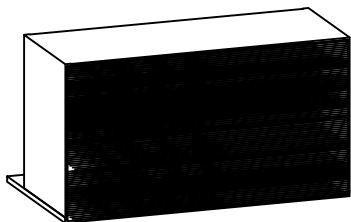

PR1		24
-----	--	----

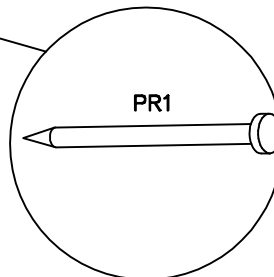

06 PASSO/ PASO/ STEP

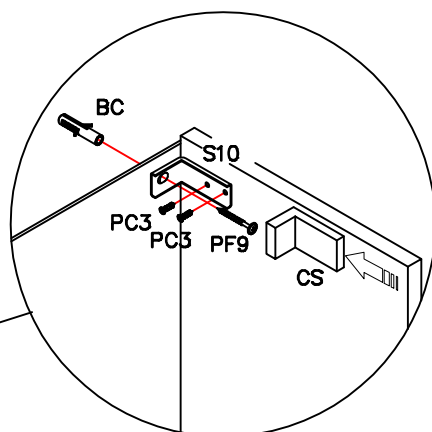
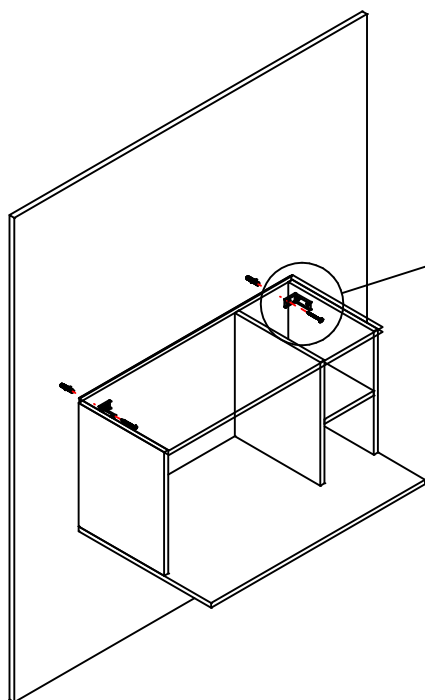

PF9		2
-----	--	---

PC3		4
PC4		2
S10		2
CS		2
BC		2
TP2		2



União de Módulos

Unión de Módulos

Fasten Cabinets Together

