



NOVO  
HORIZ  
ONTE

[www.moveisnovohorizonte.com.br](http://www.moveisnovohorizonte.com.br)

## MÓDULO AÉREO SOLTEIRO RIZON

ALT.: 2365mm | LARG.: 1258mm | PROF.: 565mm



CURTA NOSSA PÁGINA  
NO FACEBOOK  
LINK AO LADO (QR CODE)



### FICHA TÉCNICA

PRODUTO 100% MDF  
ACABAMENTO EM ALTO BRILHO ULTRAVIOLETA E HD  
DOBRADIÇAS DE PRESSÃO 35mm

PARA ASSISTÊNCIA TÉCNICA, INDICAR NOME,  
CÓDIGO E COR DA PEÇA.







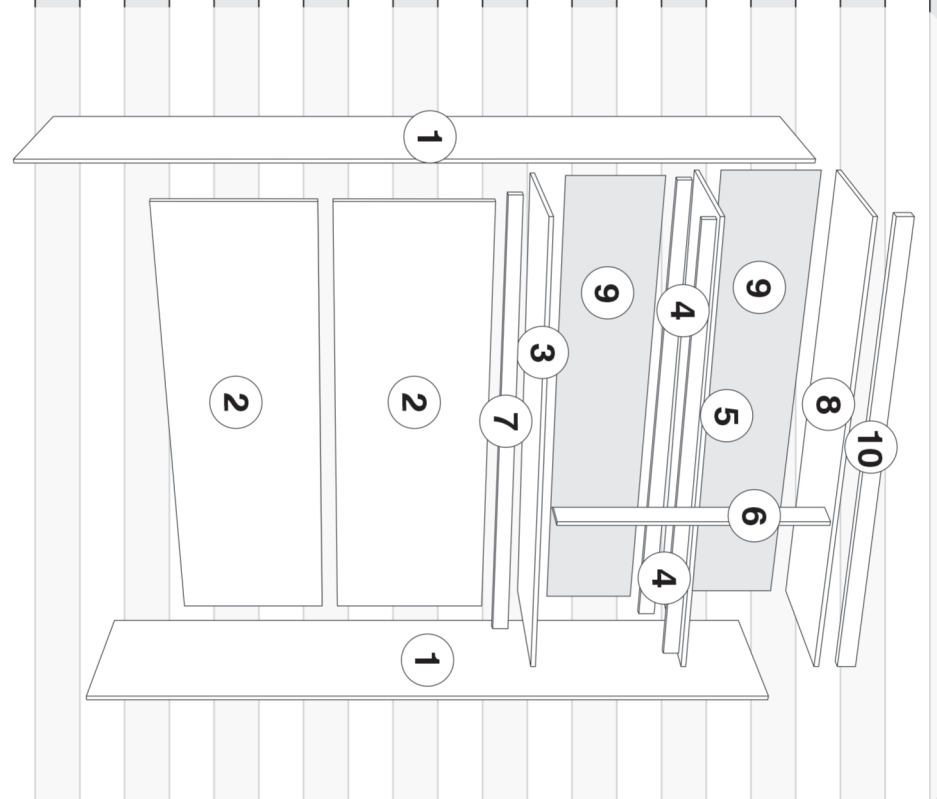





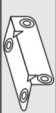

PARA SOLICITAR FERRAGENS, UTILIZE A  
LISTA DA PÁGINA 3.

## RELAÇÃO / QUANTIDADE DE PEÇAS

CÓDIGO	Nº	DESCRIÇÃO DAS PEÇAS	COMPR.	LARG.	QUANT.
14352	01	LATERAL	2364	540	02
14370	02	PAINEL CABECEIRA	1233	540	02
14365	03	BASE	1233	540	01
14369	04	TRAVESSA PRATELEIRA	1233	60	02
14366	05	PRATELEIRA	1233	442	01
14356	06	DIVISÃO	778	98	01
14368	07	TRAVESSA BASE	1233	60	01
14364	08	TAMPO	1233	540	01
14367	09	COSTAS	1255	401	02
14371	10	MOLDURA SUPERIOR	1258	60	01
14362	11	PORTA	860	412	03



# RELAÇÃO / QUANTIDADE DE FERRAGENS

CÓDIGO	LETRA	DESCRIÇÃO DAS FERRAGENS	QUANT.
2272	A	PARAFUSO 5x40 PHI 	30
3879	F2	CALÇO PARA DOBRADIÇA 	06
1409	E9	DOBRADIÇA 35mm 	06
1453	D9	CANTONEIRA 4 FUROS 	03
14868	H7	CHATA RETA 4 FUROS 	03
10250	S8	TAPA FURO 6mm INTERNO 	04
14699	C6	PREGO 8x8 	40
1117	E2	SAPATA PLÁSTICA 15x15 	04
1158	E6	GIZ 	02
1422	F	PARAFUSO 3,5x35 CHATA PHI 	08
3376	B8	PARAFUSO UNIÃO M4x22 FEMEA CHATA 	04
14754	B9	PARAFUSO UNIÃO M4x12 MACHO CHATA 	04
2041	M	PARAFUSO 3,5x12 CHATA PHI 	55
14421	T7	FIXADOR DE COSTAS METÁLICO 	12
12342	Z5	TAPA FURO ADESIVO 17mm 	46

## NECESSÁRIO PARA MONTAGEM

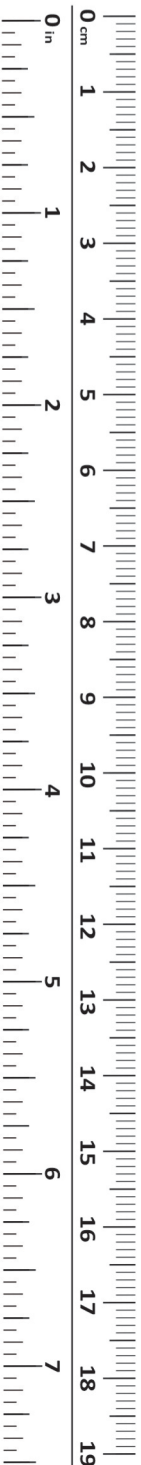
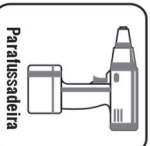
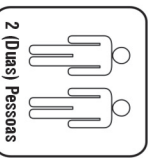

UTILIZE A RÉGUA PARA A MEDIÇÃO DOS PARAFUSOS

① PARAFUSAR PAINEL CABECEIRA.

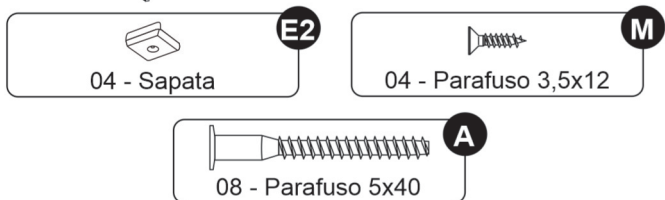
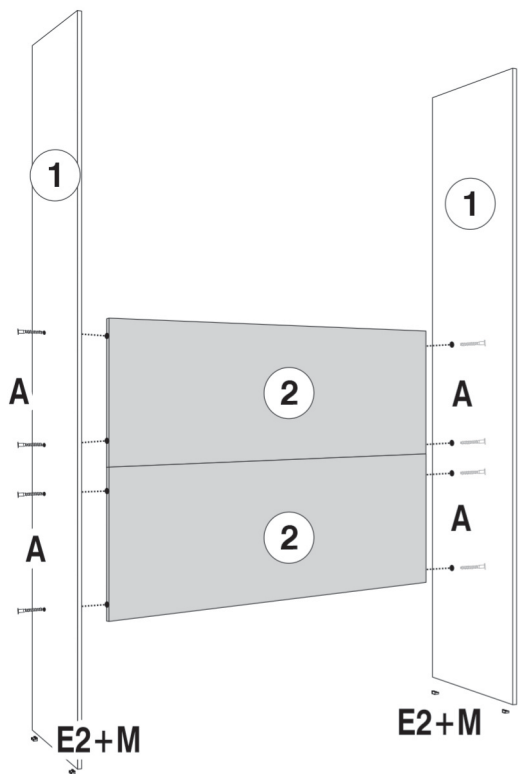

② UNIR PAINÉIS CABECEIRA.

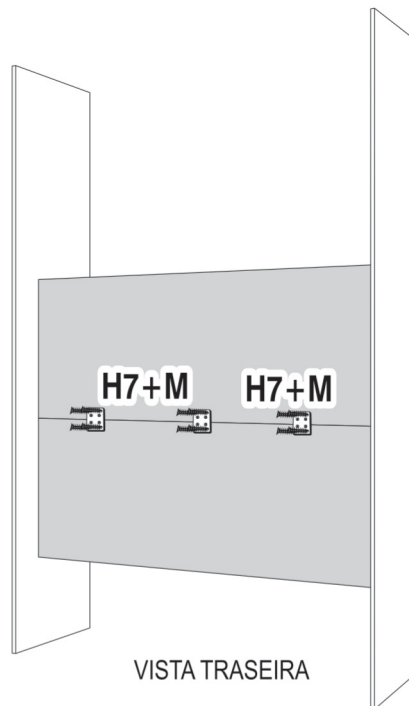

③ PARAFUSAR BASE.

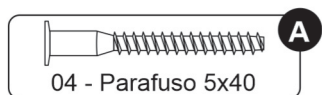
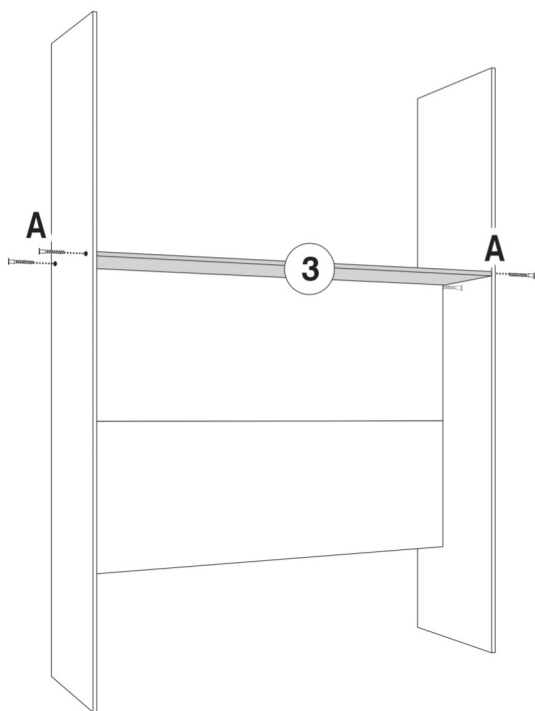

④ PARAFUSAR TRAVESSAS PRATELEIRA E PRATELEIRA.

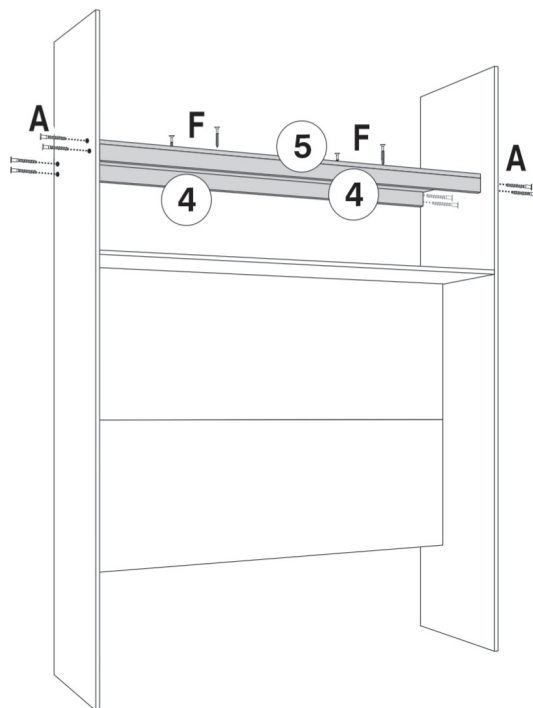

5 PARAFUSAR DIVISÃO.

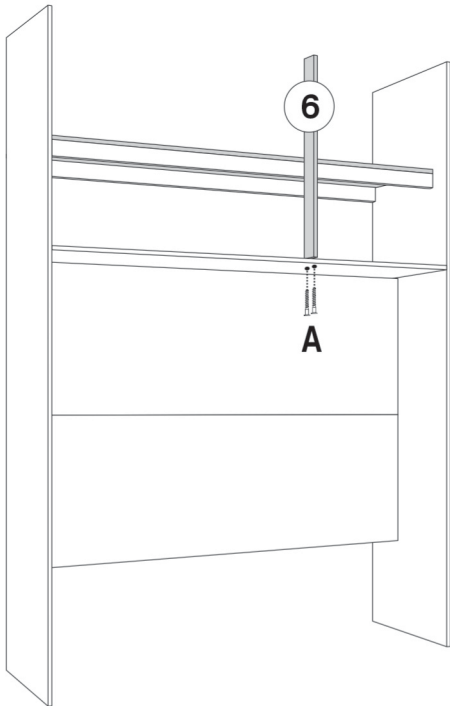

6 PARAFUSAR TRAVESSA BASE.

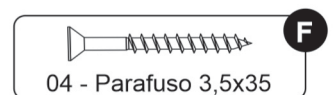
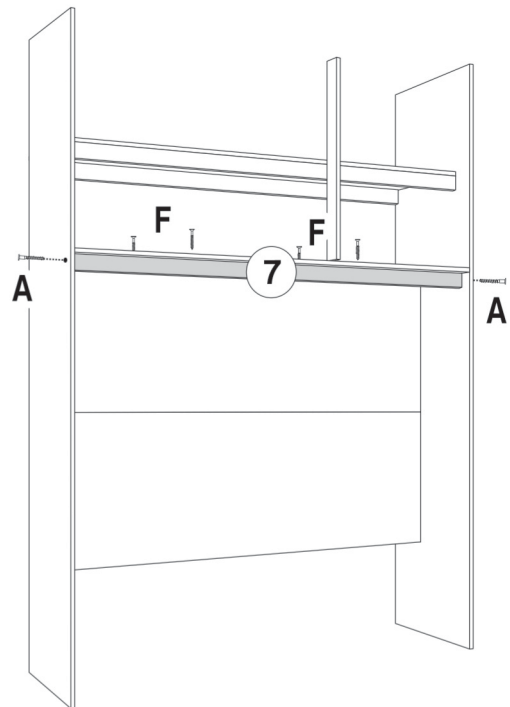

7 MONTAR MOLDURA NO TAMPO.

ATENÇÃO: FIXAR A MOLDURA A 5,5cm COM CANTONEIRA 4 FUROS CONFORME DESENHO ABAIXO.

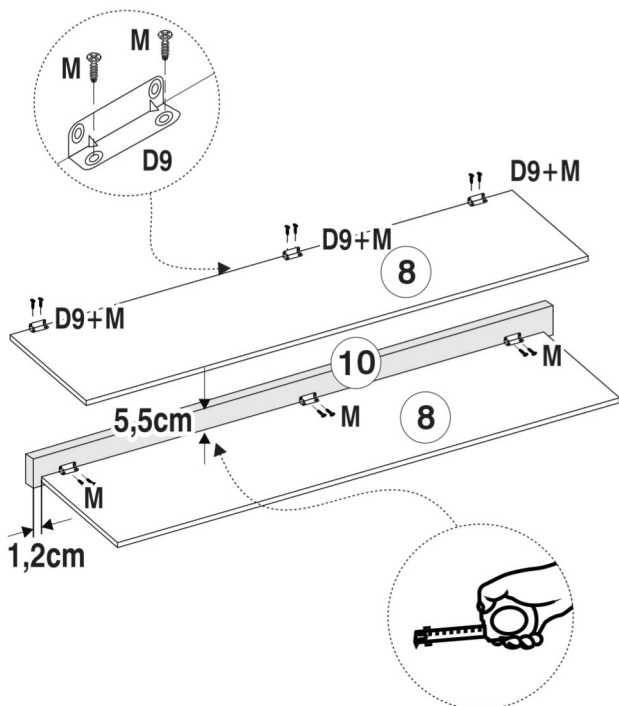

8 FIXAR TAMPO.

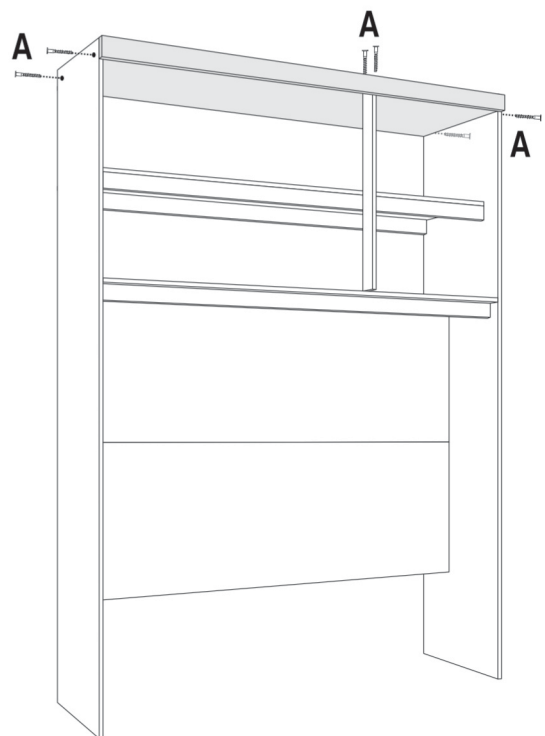

9 PREGAR AS COSTAS.

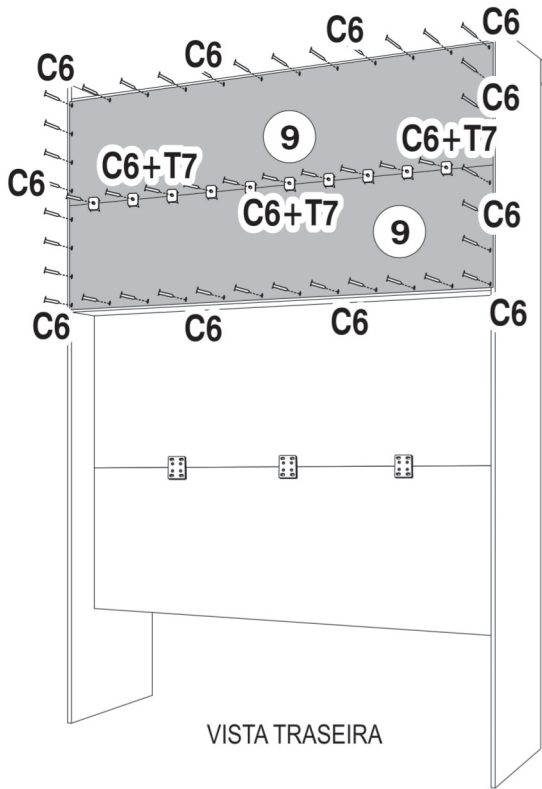

VISTA TRASEIRA



40 - PREGO 8x8

C6



12 - FIXADOR COSTAS

T7

10 MONTAR PORTAS.

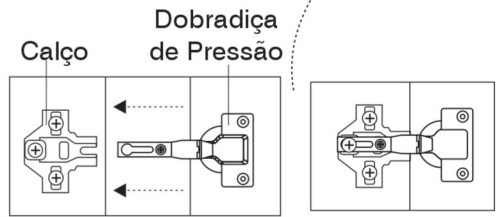
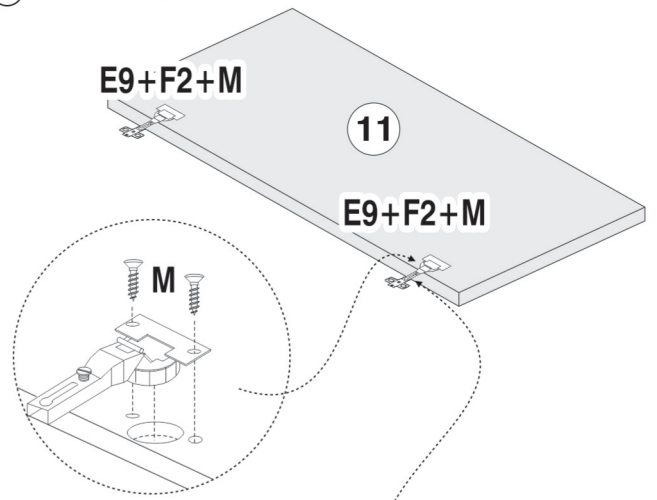

12 - PARAF. 3,5x12

M



06 - DOBRADIÇA PRESSÃO

E9



06 - CALÇO

F2

11 FIXAR AS PORTAS.

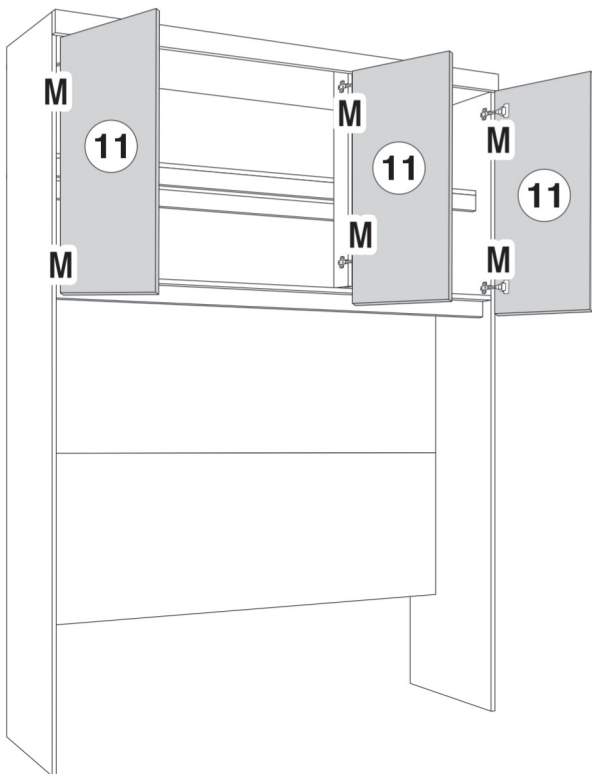

12 - PARAF. 3,5x12

M

12 PRODUTO MONTADO.

