



NOVO
HORIZ
ONTE

www.moveisnovohorizonte.com.br

MÓDULO 1 PORTA RIZON

ALT.: 2365mm | LARG.: 409mm | PROF.: 565mm



CURTA NOSSA PÁGINA
NO FACEBOOK
LINK AO LADO (QR CODE)



FICHA TÉCNICA

PRODUTO 100% MDF
ACABAMENTO EM ALTO BRILHO ULTRAVIOLETA E HD
DOBRADIÇAS DE PRESSÃO 35mm

PARA ASSISTÊNCIA TÉCNICA, INDICAR NOME,
CÓDIGO E COR DA PEÇA.

PARA SOLICITAR FERRAGENS, UTILIZE A
LISTA DA PÁGINA 2.

RELAÇÃO / QUANTIDADE DE PEÇAS

CÓDIGO		LETRA	DESCRIÇÃO DAS PEÇAS	COMPR.	LARG.	QUANT.
14400	01		RODAPÉ FRONTAL	384	110	01
14401	02		RODAPÉ TRASEIRO	384	110	01
14393	03		BASE	540	384	01
14727	04		LATERAL DIREITA	2364	540	01
14728	05		LATERAL ESQUERDA	2364	540	01
14399	06		PRATELEIRA	430	384	03
14394	07		TAMPO	540	384	01
14397	08		COSTAS	2200	406	01
14398	09		MOLDURA SUPERIOR	409	60	01
14402	10		PORTA	2190	393	01

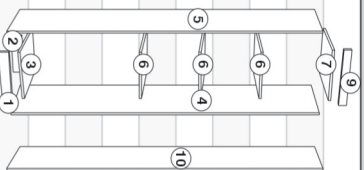

RELAÇÃO / QUANTIDADE DE FERRAGENS

CÓDIGO		LETRA	DESCRIÇÃO DAS FERRAGENS	QUANT.
2272	A		PARAFUSO 5x40 PHI	24
3879	F2		CALÇO PARA DOBRADIÇA	03
1409	E9		DOBRADIÇA 35mm	03
1453	D9		CANTONEIRA 4 FUROS	02
2051	D7		SUPORTE CABIDEIRO	02
14699	C6		PREGO 8x8	51
1117	E2		SAPATA PLÁSTICA 15x15	04
1158	E6		GIZ	02
1422	F		PARAFUSO 3.5x35 CHATA PHI	02
2195	X7		PARAFUSO 3.5x25 FLANG. SEM PONTA	02
3376	B8		PARAFUSO UNIÃO M4x22 FEMEA CHATA	04
14754	B9		PARAFUSO UNIÃO M4x12 MACHO CHATA	04
2041	M		PARAFUSO 3.5x12 CHATA PHI	28
10250	S8		TAPA FURO 6mm INTERNO	08
12342	Z5		TAPA FURO ADESIVO 17mm	32

RELAÇÃO / QUANTIDADE DE ACESSÓRIOS

CÓDIGO		LETRA	DESCRIÇÃO DOS ACESSÓRIOS	QUANT.
5068	T6		TUBO OBLONGO 374mm	01
12125	Z3		PUXADOR MDF 523mm	01

NECESSÁRIO PARA MONTAGEM

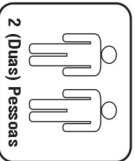

UTILIZE A REGUA PARA A MEDIÇÃO DOS PARAFUSOS

① PARAFUSAR RODAPÉ NAS LATERAIS.

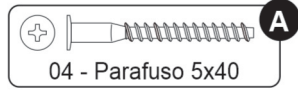
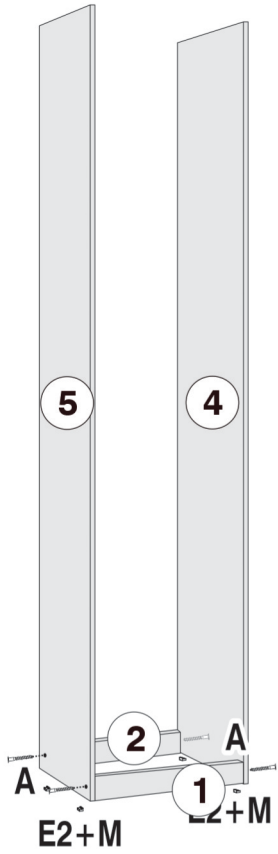

② PARAFUSAR BASE.

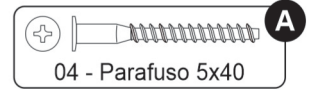
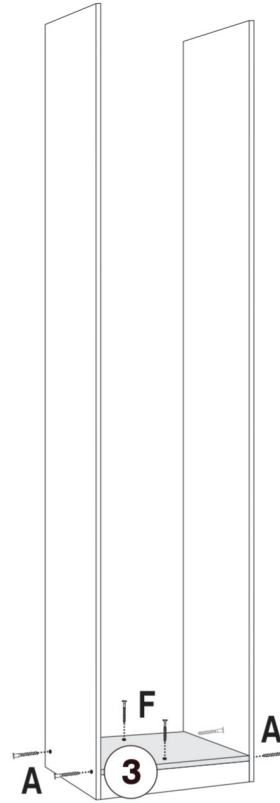

③ PARAFUSAR PRATELEIRAS.

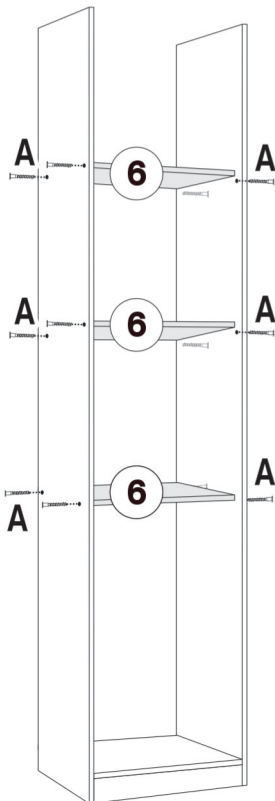

④ PREPARAR DO TAMPO.

ATENÇÃO: FIXAR A MOLDURA A 5,5cm COM CANTONEIRA 4 FUROS CONFORME DESENHO ABAIXO.

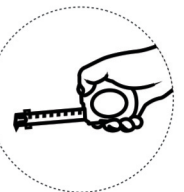
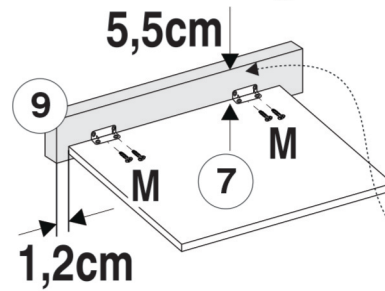
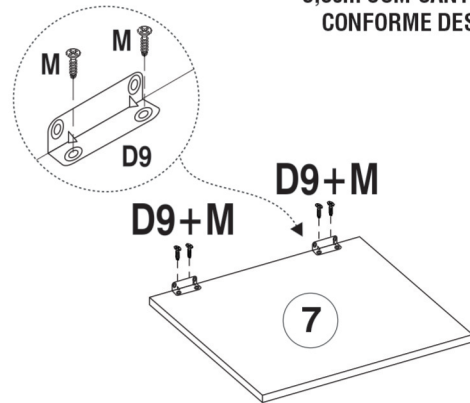

5) FIXAR TAMPO E PARAFUSAR O SUPORTE CABIDEIRO.

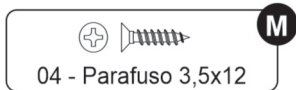
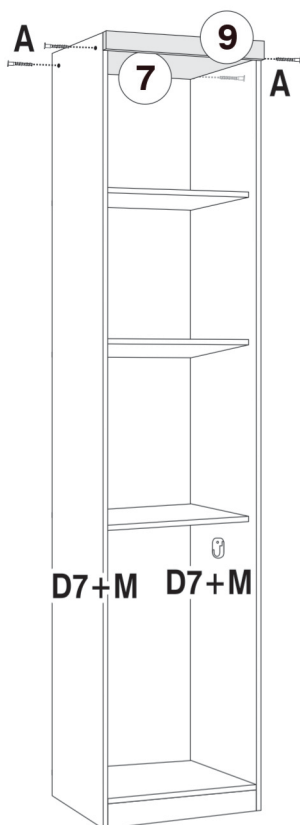

6) PREGAR A COSTAS.

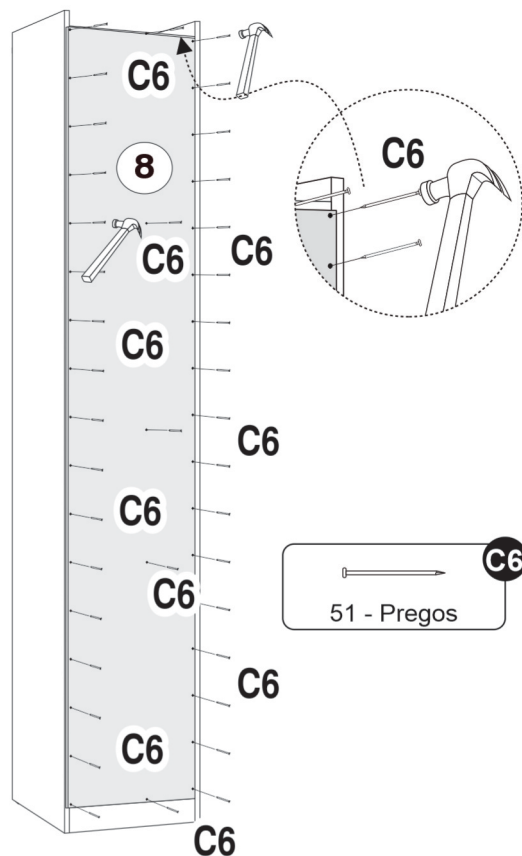

7) EFETUAR A MONTAGEM DA PORTA.

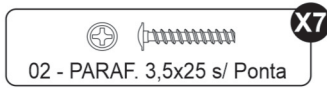
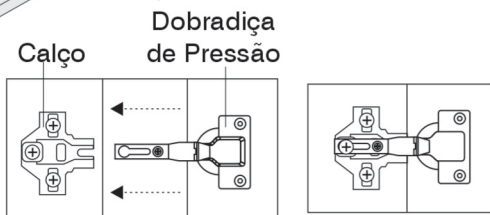
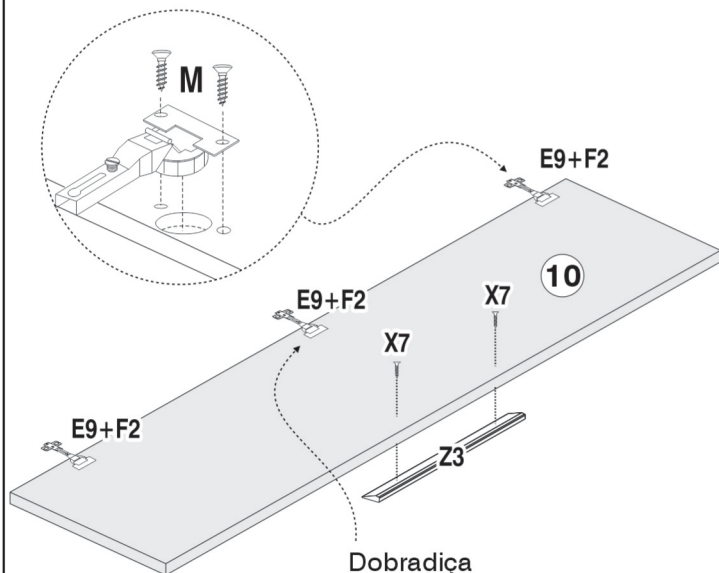

8) FIXAR PORTA.

