

Kit Cozinha Compacta 1050mm

c B109-21 - Fendi/Rústico

c B109-85 - Moka/Fendi

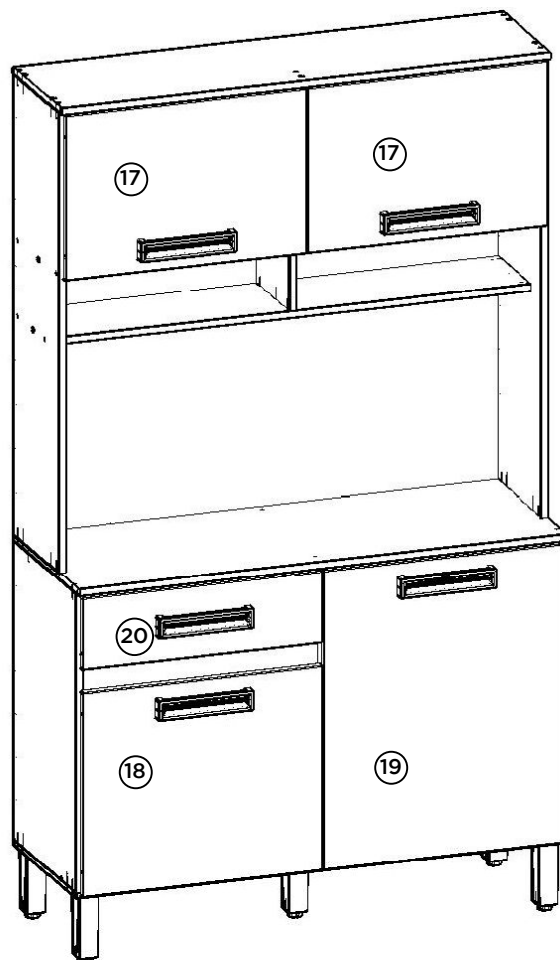
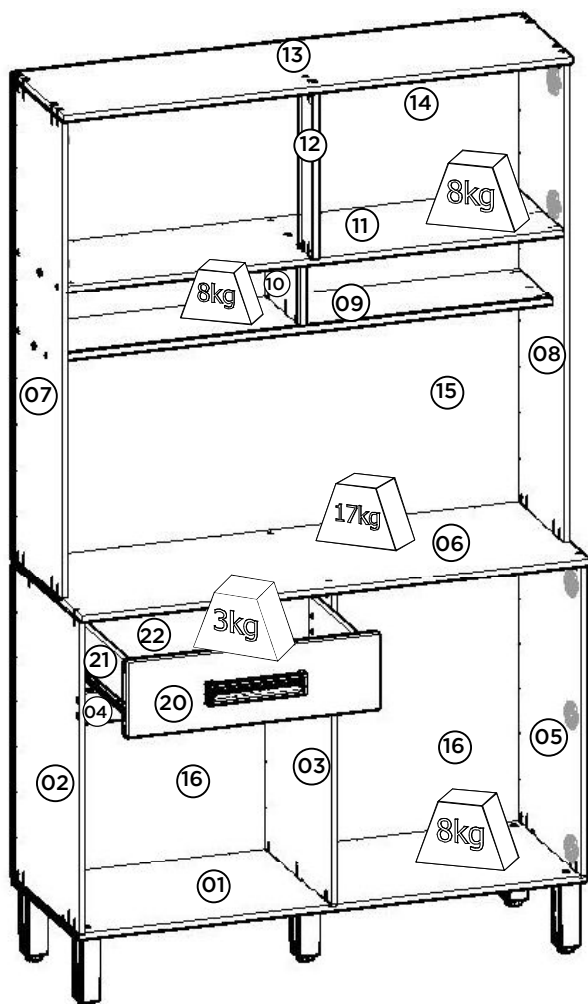

Pesos máximos recomendados com carga uniformemente distribuídas.
Peso máximo recomendado con la carga distribuida uniformemente.
Recommended maximum weights with evenly distributed.

Requisitos para montagem Requisitor para la montaje Assembly Requirements

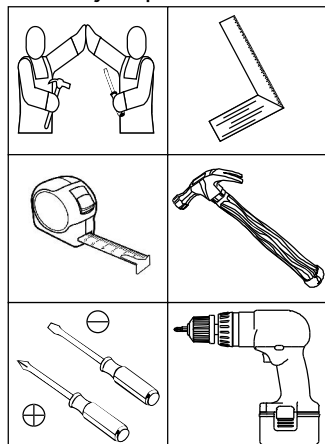

Imagens meramente ilustrativas
Imágenes meramente ilustrativas
Images for illustration only

AVISO

Para limpeza de seu móvel, use uma flanela seca ou umedecida, e não utilize produtos químicos que possam danificar seu produto.

SISTEMA DE MONTAGEM

O sistema de montagem dos produtos, funciona de acordo com a ordem crescente dos números indicados no desenho. Ex: 01, 02, 03, 04... até a conclusão da montagem.

ADVERTENCIA

Para limpieza de su móvil, use una flanela seca o húmeda, y no utilice productos químicos que puedan dañar su producto.

SISTEMA DE MONTAJE

El sistema de montaje de los productos funciona de acuerdo con el orden creciente de los números indicados en el dibujo. Ej.: 01, 02, 03, 04... hasta la conclusión del montaje.

NOTICE

To clean your furniture, use a dry or wet cloth, and do not use chemicals that may damage your product.

ASSEMBLY SYSTEM

The products' assembly system works according to the increasing order of the indicated numbers. For example: 01, 02, 03, 04 ... to the end of the assembly.

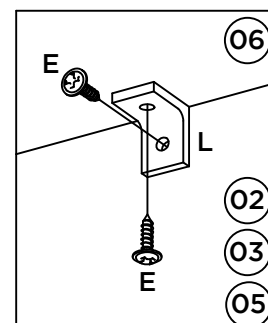
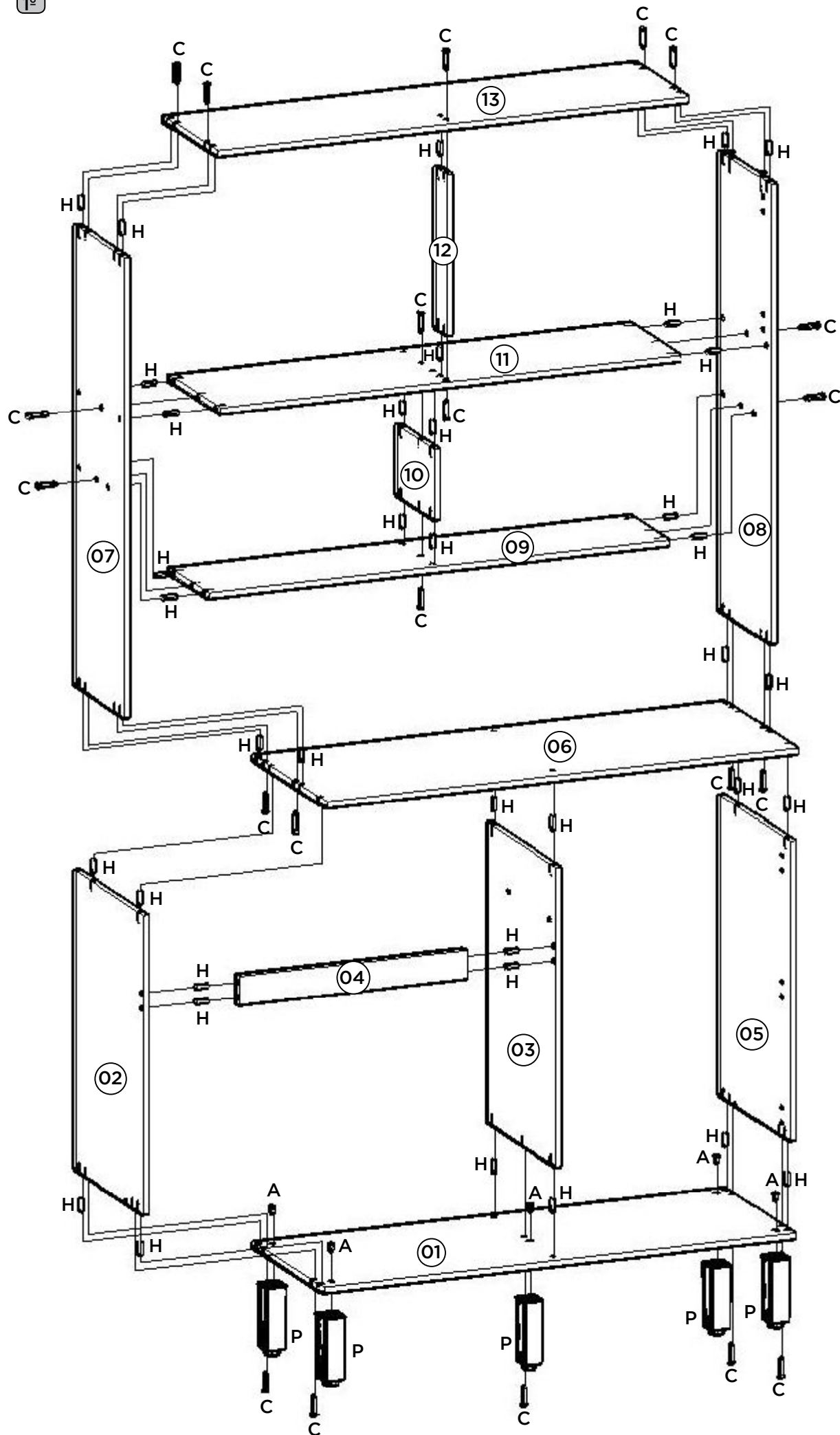

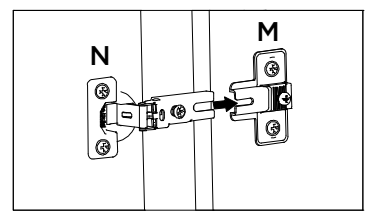
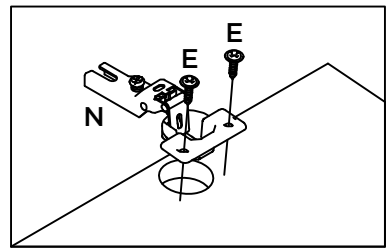
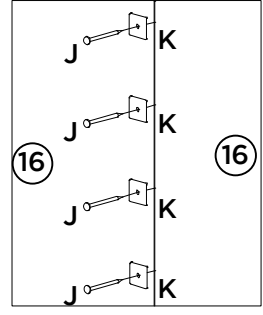
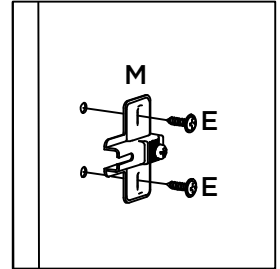
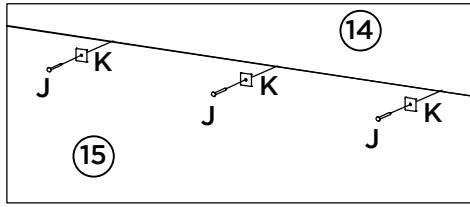
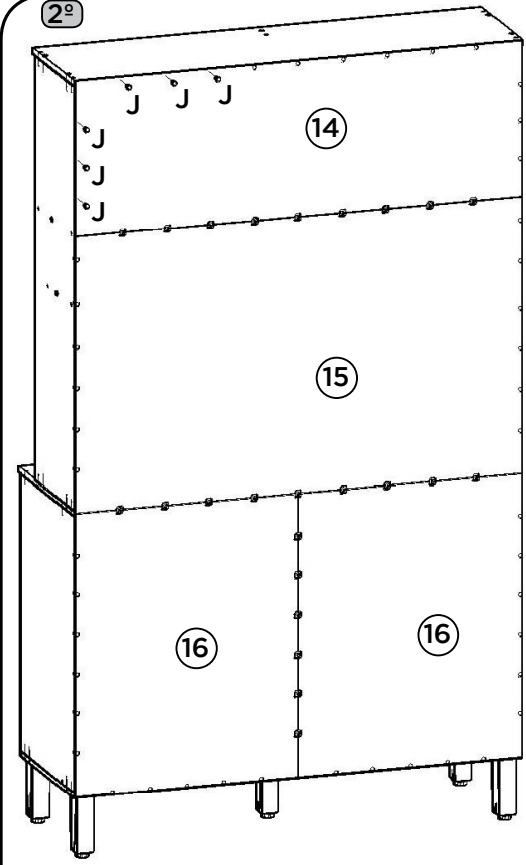

3º

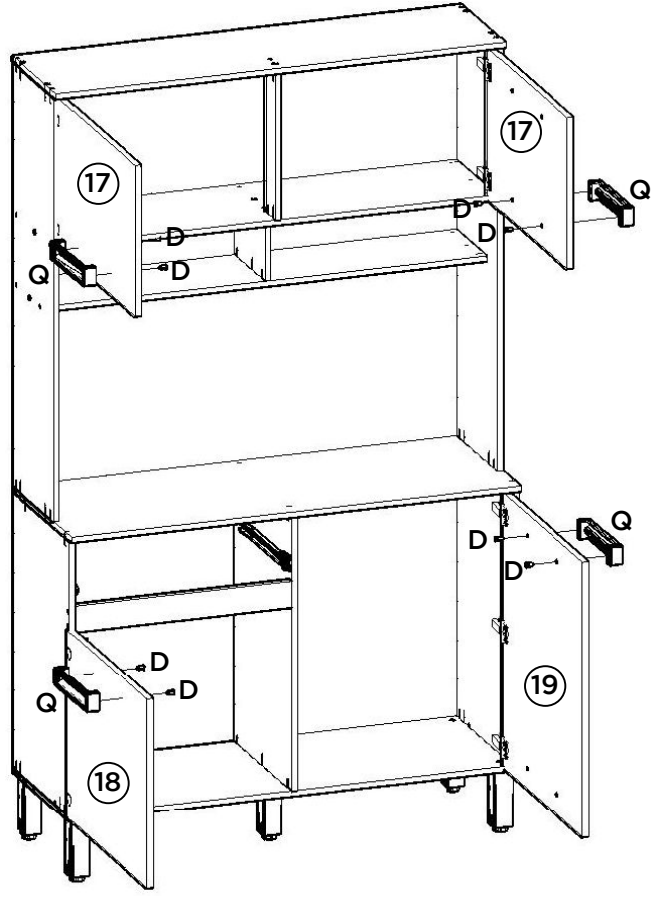
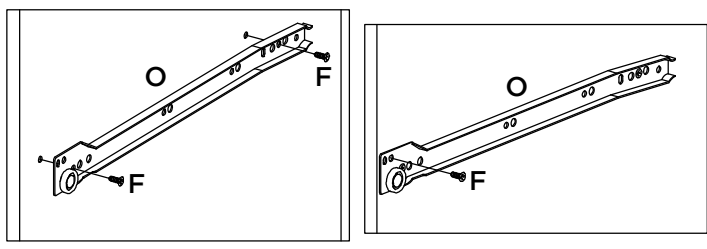

4º

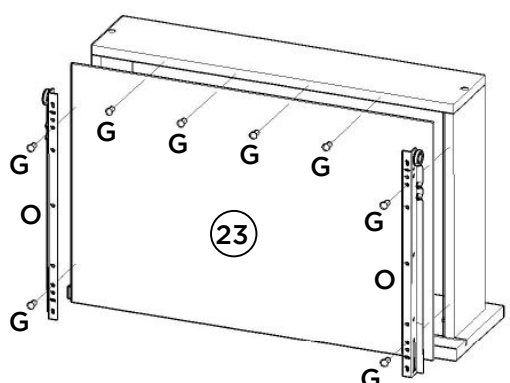
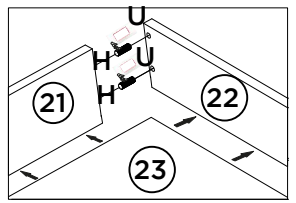
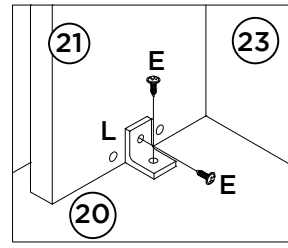
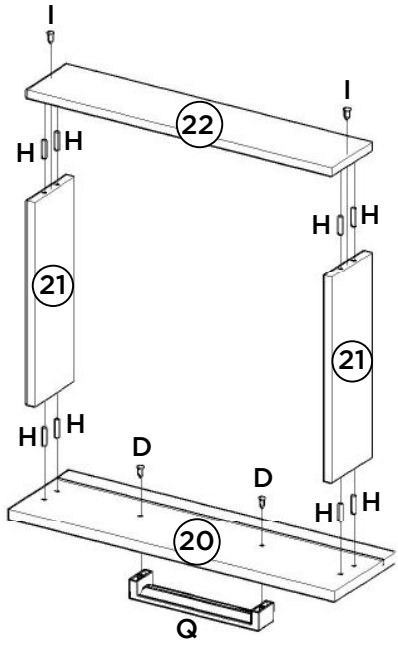





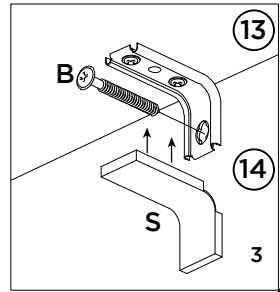
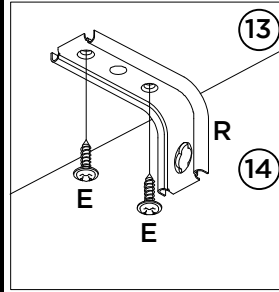













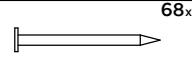
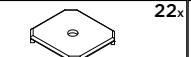

Fixação do móvel na parede. montaje en la pared móvil.

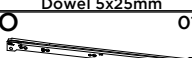
Attach the furniture to the wall.

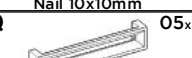

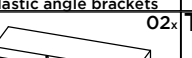
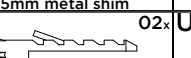
Item	Caixa Caja Box	Qty Ctd Qty	Descrição Descripción Description	Medidas (mm) Dimensions (mm) Size (measurements) (mm)
01	1/1	01	Base Base Base	1500x365x12
02	1/1	01	Lateral Esquerda Balcão Pia Lado Izquierdo Entarrar Left Side of the Balcony	638x365x12
03	1/1	01	Divisão Balcão División turística Balcony Division	638x365x12
04	1/1	01	Travessa Inferior Frontal Travesaño delantero inferior Front Lower Tray	507x60x12
05	1/1	01	Lateral Direita Balcão Pia Lado derecho Entarrar Right Side of the Counter	638x365x12
06	1/1	01	Tampo Tapa Top	1050x380x12
07	1/1	01	Lateral Esquerda Superior Lado Izquierdo Superior Upper Left Side	981x265x12
08	1/1	01	Lateral Direita Superior Lado Derecho Superior Top Right Wing	981x265x12
09	1/1	01	Prateleira Nicho Estantería de nicho Niche Shelf	1026x200x12
10	1/1	01	Divisória Tabique Partition	198x150x12
11	1/1	01	Prateleira Aéreo 1050mm Plataforma aérea 1050mm 1050mm Aerial Shelf	1026x265x12
12	1/1	01	Pilastra Aéreo 1050mm Aire pilastra 1050mm Air Pilon 1050mm	343x60x12
13	1/1	01	Tampo Aéreo 1050mm 1050 mm de aire de la superficie Air Top 1050mm	1052x280x12
14	1/1	01	Fundo Aéreo 1050mm Fondo Aéreo 1050mm 1050 Air Fund	1045x359x3
15	1/1	01	Fundo Central Fondo central Central Fund	1045x637x3
16	1/1	02	Fundo Balcão Pia Pia Balcón Suelo Bottom Pia Background	653x522x3
17	1/1	02	Porta Puerta Door	516x350x15
18	1/1	01	Porta Menor Balcão Pia Porta Pia Baja Balcón Minor Door Pia Balcony	516x435x15
19	1/1	01	Porta Balcão Pia Porta Pia Escritorio Pia Door Counter	637x516x15
20	1/1	01	Frente de gaveta Frente de cajón Front of drawer	516x152x15
21	1/1	02	Lado de gaveta Lado del cajón Side of drawer	300x100x12
22	1/1	01	Ripa de trás Malla detrás Rear lath	482x100x12
23	1/1	01	Fundo de gaveta Fondo del cajón Drawer bottom	481x317x3

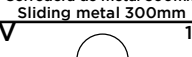
Ferragens | Herrajes | Hardware

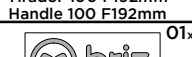
A  Parafuso 7,0x40mm CHT. Tornillo 7,0x40mm CHT. Screw 7,0x40mm CHT.	05x	B  Parafuso 5,0x50mm FLA. Tornillo 5,0x50mm FLA. Screw 5,0x50mm FLA.	02x	C  Parafuso 3,5x40mm CHT. Tornillo 3,5x40mm CHT. Screw 3,5x40mm CHT.	21x	D  Parafuso 3,5x25mm FLA. Tornillo 3,5x25mm FLA. Screw 3,5x25mm FLA.	10x	E  Parafuso 3,5x12mm FLA. Tornillo 3,5x12mm FLA. Screw 3,5x12mm FLA.	50x	F  Parafuso 3,5x12mm CHT. Tornillo 3,5x12mm CHT. Screw 3,5x12mm CHT.	06x	G  Parafuso 3,0x16mm CHT. Tornillo 3,0x16mm CHT. Screw 3,0x16mm CHT.	08x
H  Cavilha 5x25mm Cinta 5x25mm Dowel 5x25mm	46x	I  Prego 12x12mm Anelado Clavo 12x12mm Anillado Ringed Nails 12x12mm	02x	J  Prego 10x10mm Clavo 10x10mm Nail 10x10mm	68x	K  Fixador de fundos Fijador de fondos Bottom fixer	22x	L  Cantoneira plástica Cantonera plástica Plastic angle brackets	05x	M  Calço metal 5mm Calzado metálico 5mm 5mm metal shim	09x	N  Dobradiça metal 26mm Bisagra de metal 26mm 26mm metal hinge	09x
O  Corredora metal 300mm Corredora de metal 300mm Sliding metal 300mm	01x	P  Pé 145mm x 42mm Pie 145mm x 42mm Foot 145mm x 42mm	05x	Q  Puxador 100 F192mm Tirador 100 F192mm Handle 100 F192mm	05x	R  Suporte de fixação Soporte de fijación Mounting bracket	02x	S  Proteção para cantoneira Ángulo de protección Protection angle	02x	T  Bucha plástica 8mm Bucha de plástico 8mm 8mm plastic bushing	02x	U  Sachê de cola Bolsa de pegamento Glue bag	01x
V  Adesivo tampa parafuso 10mm Adhesivo tapón de tornillo 10mm Bolt cover adhesive 10mm	11x	W  Adesivo tampa parafuso 17mm Adhesivo tapón de tornillo 17mm Bolt cover adhesive 17mm	04x	X  Etiqueta resinada Briz Etiqueta resinada Briz Briz resin label	01x								