



NOVO  
HORIZ  
ONTE

[www.moveisnovohorizonte.com.br](http://www.moveisnovohorizonte.com.br)

## MÓDULO CANTO RIZON

ALT.: 2365mm | LARG.: 805mm | PROF.: 565mm

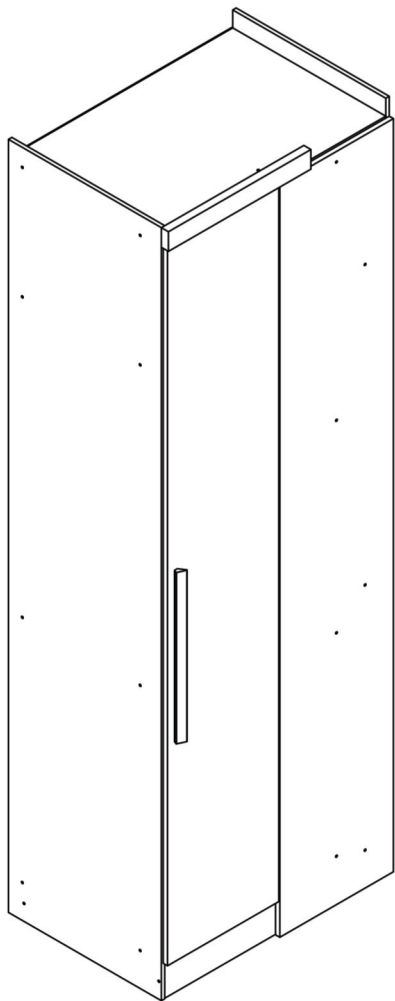

### OPÇÕES DE MONTAGEM

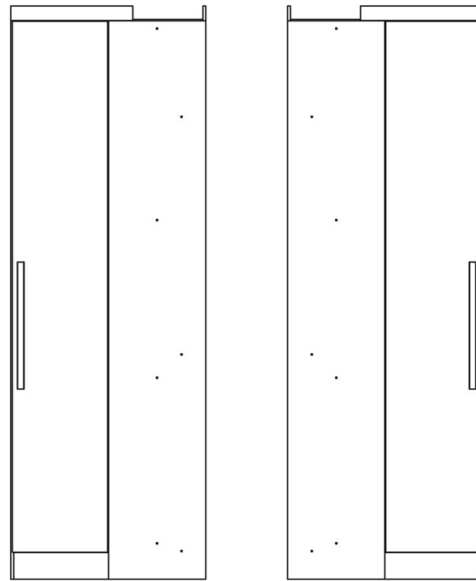

CURTA NOSSA PÁGINA  
NO FACEBOOK  
LINK AO LADO (QR CODE)



#### FICHA TÉCNICA

PRODUTO 100% MDF  
ACABAMENTO EM ALTO BRILHO ULTRAVIOLETA E HD  
DOBRADIÇAS DE PRESSÃO 35mm

PARA ASSISTÊNCIA TÉCNICA, INDICAR NOME,  
CÓDIGO E COR DA PEÇA.

PARA SOLICITAR FERRAGENS, UTILIZE A  
LISTA DA PÁGINA 3.

## RELAÇÃO / QUANTIDADE DE PEÇAS

CÓDIGO	Nº	DESCRIÇÃO DAS PEÇAS	COMPR.	LARG.	QUANT.
14413	01	RODAPÉ FRONTAL	780	110	01
14414	02	RODAPÉ TRASEIRO	780	110	01
14407	03	BASE	780	540	01
14729	04	LATERAL DIREITA	2364	540	01
14730	05	LATERAL ESQUERDA	2364	540	01
14418	06	PRATELEIRA	780	540	02
14420	07	APOIO DOBRADIÇA SUPERIOR	384	86	01
14422	08	APOIO DOBRADIÇA CENTRAL	968	86	01
14423	09	APOIO DOBRADIÇA INFERIOR	799	86	01
14408	10	TAMPO	780	540	01
14409	11	COSTAS	2200	795	01
14417	12	MOLDURA SUPERIOR	503	60	01
14402	13	PORTA	2190	393	01
14419	14	CONEXÃO	2303	401	01

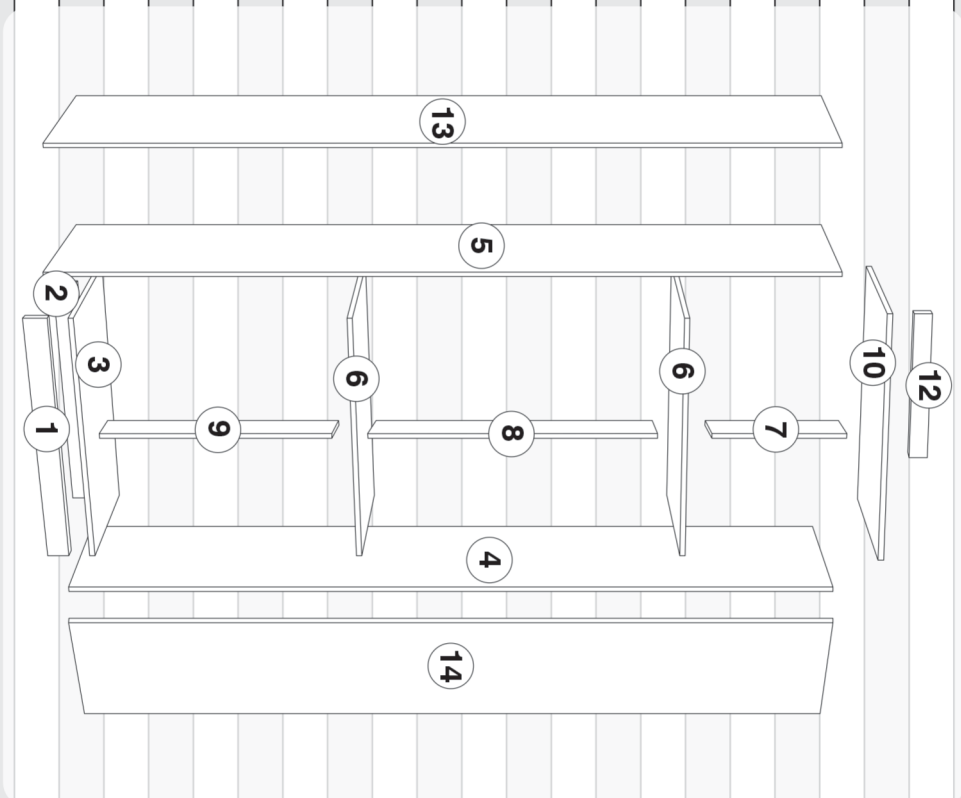

# RELAÇÃO / QUANTIDADE DE FERRAGENS

CÓDIGO	LETRA	DESCRIÇÃO DAS FERRAGENS	QUANT.
2272	A	PARAFUSO 5x40 PHI	20
3879	F2	CALÇO PARA DOBRADIÇA	03
1409	E9	DOBRADIÇA 35mm	03
1404	C8	CAVILHA 6x30	04
2498	Y5	CAVILHA 6x50	04
1453	D9	CANTONEIRA 4 FUROS	12
2051	D7	SUPORTE CABIDEIRO	04
14699	C6	PREGO 8x8	50
1117	E2	SAPATA PLÁSTICA 15x15	06
1158	E6	GIZ	02
2214	N	PARAFUSO 3.5x30 CHATA PHI	07
2195	X7	PARAFUSO 3.5x25 FLANG. SEM PONTA	02
3376	B8	PARAFUSO UNIÃO M4x22 FEMEA CHATA	04
14754	B9	PARAFUSO UNIÃO M4x12 MACHO CHATA	04
2041	M	PARAFUSO 3.5x12 CHATA PHI	78
12342	Z5	TAPA FURO ADESIVO 17mm	28

# RELAÇÃO / QUANTIDADE DE ACESSÓRIOS

CÓDIGO	LETRA	DESCRIÇÃO DOS ACESSÓRIOS	QUANT.
5070	N8	TUBO OBLONGO 772mm	02
12125	Z3	PUXADOR MDF 523mm	01

# NECESSÁRIO PARA MONTAGEM

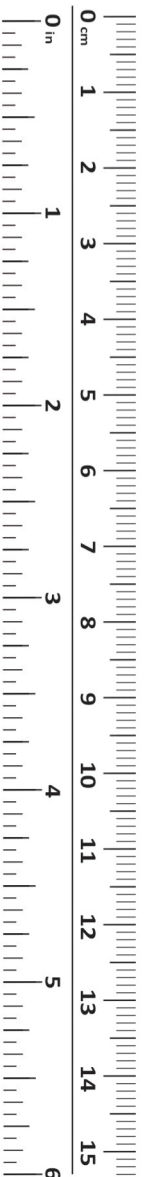
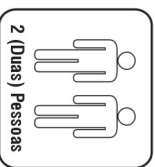

UTILIZE A RÉGUA PARA A MEDIÇÃO DOS PARAFUSOS

1 PARAFUSAR RODAPÉ NAS LATERAIS.

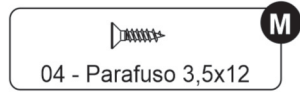
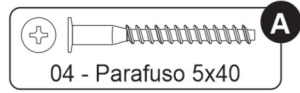
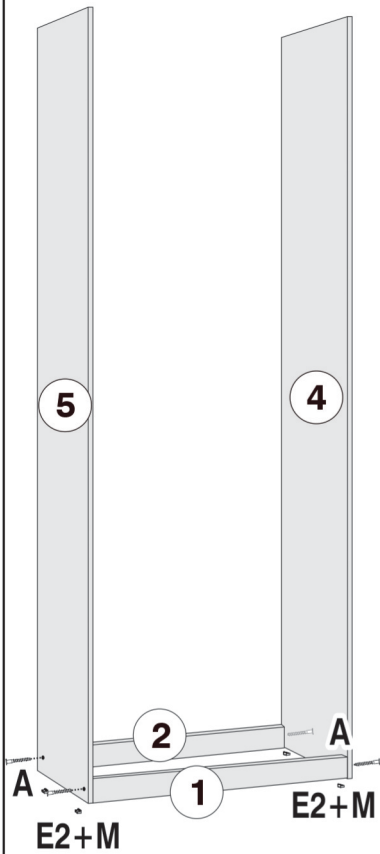

2 PARAFUSAR BASE E APOIO DOBRADOÇA INFERIOR.

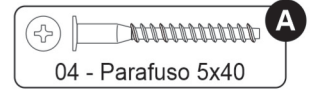
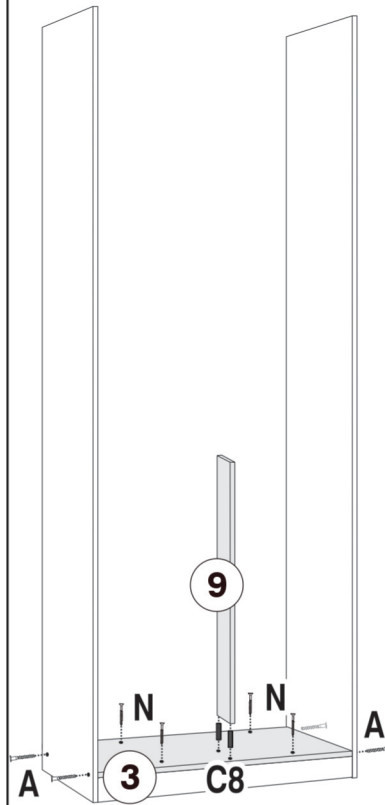

3 PARAFUSAR PRATELEIRA.

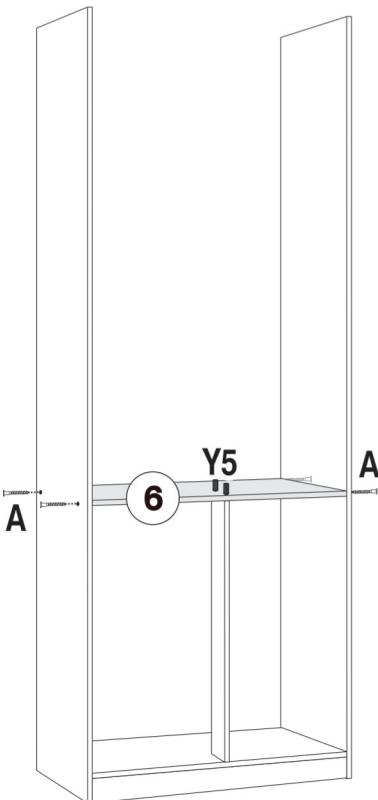

4 ENCAIXAR APOIO DOBRADIÇA CENTRAL.

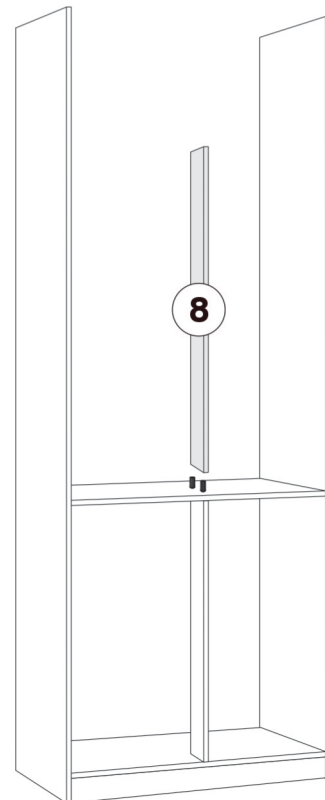

5 PARAFUSAR PRATELEIRA E SUPORTE CABIDEIRO.

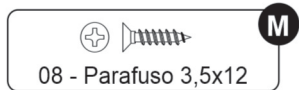
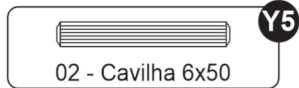
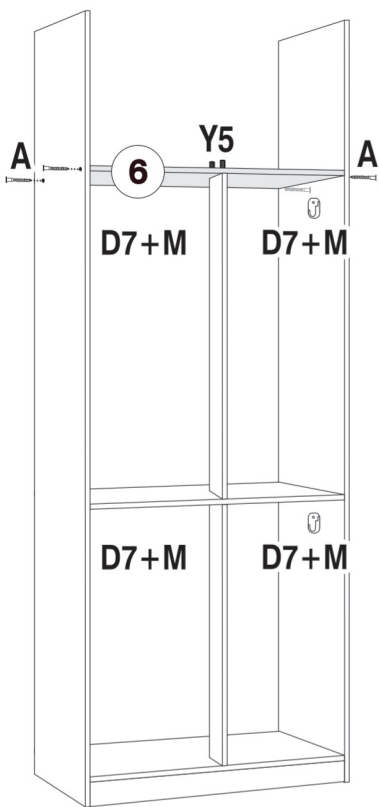

6 ENCAIXAR APOIO DOBRADIÇA SUPERIOR.

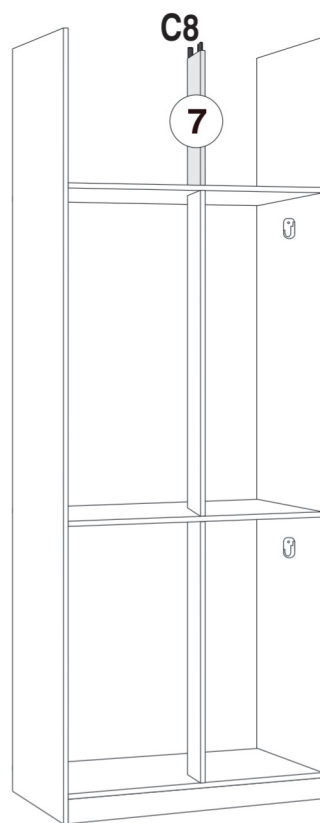

7 FIXAR TAMPO.

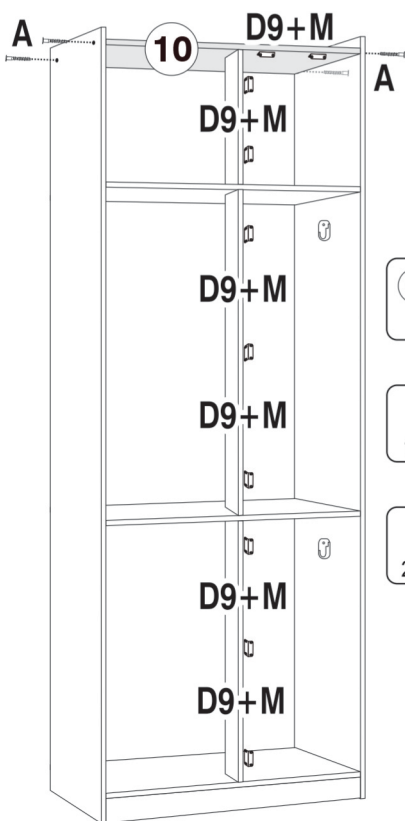

8 FIXAR CONEXÃO.

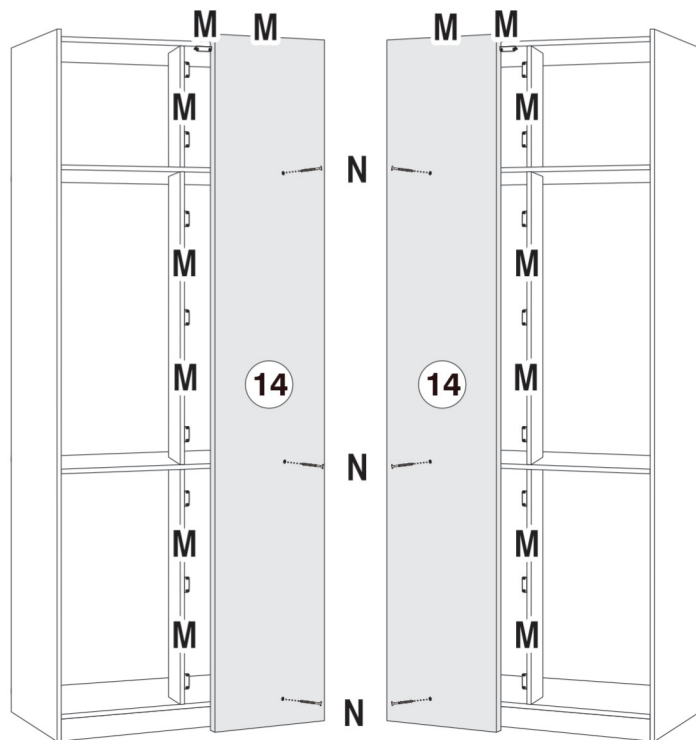

PAREDE DIREITA

PAREDE ESQUERDA



9 PREGAR A COSTAS.

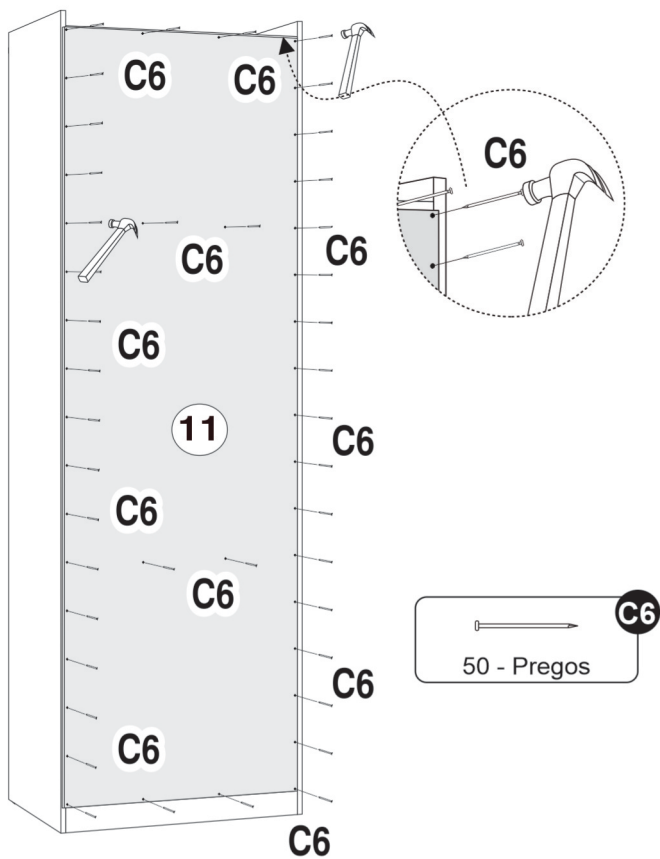

10 FIXAR MOLDURA SUPERIOR.

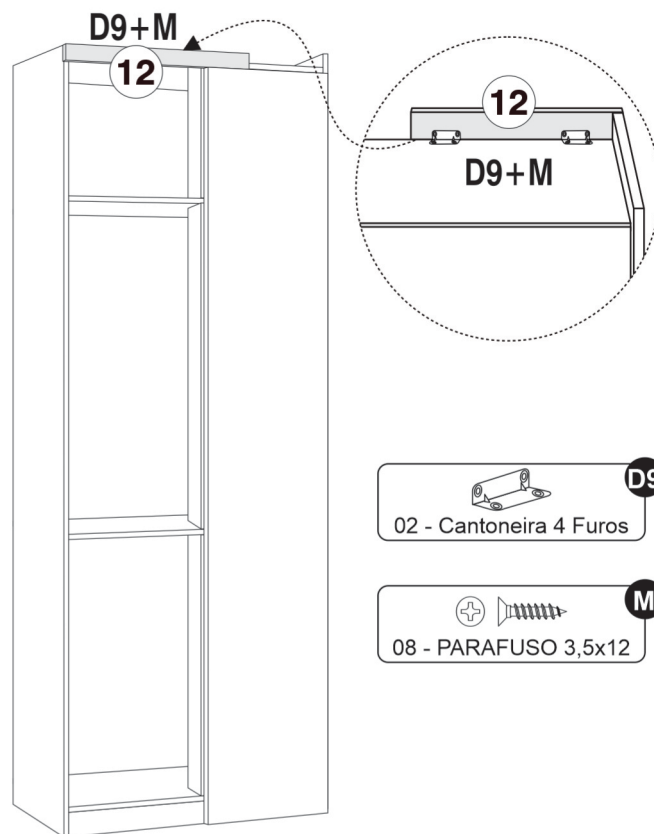

11 MONTAR A PORTA.

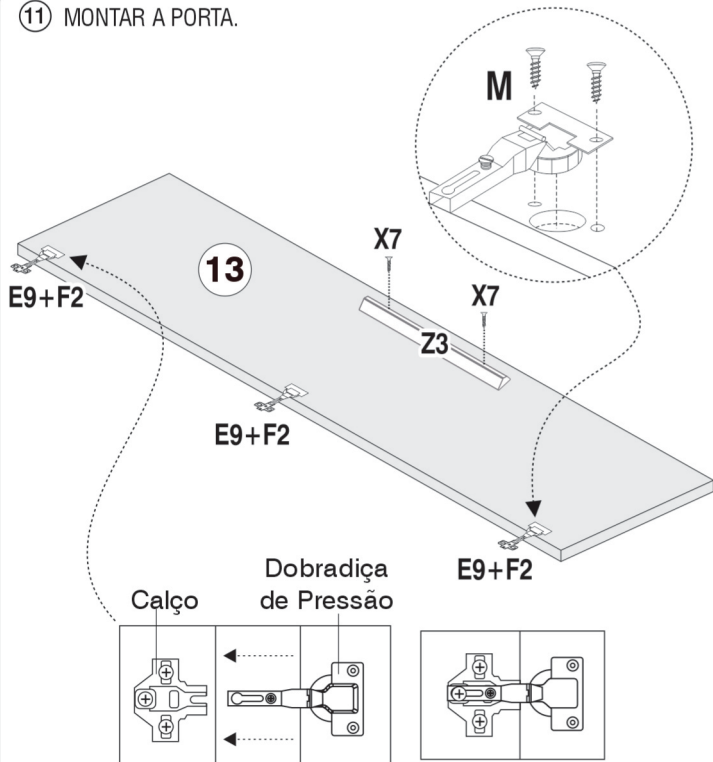

12 FIXAR PORTA.

