













RT 3032

DIMENSÕES EM MM / Dimensiones en mm / Dimensions in mm

LISTA DE PEÇAS / LISTA DE PIEZAS/ LIST OF PIECES

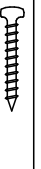
PEÇAS / PIEZAS / PIECES	Dimensões / Dimensiones	Código/code	QTD.
BASE	1 500 X 380 X 15	61378	01
LATERAL DIREITA / ESQUERDA	2 320 X 360 X 15	61381	02
TAMPO	3 500 X 380 X 15	61376	01
FRENTE DE GAVETA	4 152 X 495 X 15	61383	02
LATERAL GAVETA DIREITA	5 350 X 100 X 15	60087	02
LATERAL GAVETA ESQUERDA	6 350 X 100 X 15	67214	02
COSTA GAVETA	7 413 X 100 X 15	61382	02
BASE GAVETA	8 438 X 355 X 3	61384	02
COSTA	9 495 X 345 X 3	61385	01

FERRAGENS / HERRAJENS / HARDWARE	DIMENSÕES / Dimensiones / Dimensions	QTD.
A 	PARAFUSO ESTRUTURAL 5 x 50	12
B 	PARAFUSO CH 3,5 x 14	32
C 	CHAVEZETA ALLEN	01
D 	PARAFUSO ESTRUTURAL 7 x 50	04
E 	CAVILHA 8 MM	12
F 	ASTE DE MINIFIX	06
G 	TAMBOR 15mm	06
H 	PIÉ REDONDO MADEIRA 260 MM	04
I 	PREGO 10x10	30
J 	PARAFUSO PANELA 4,0x30	02
K 	CORREDIÇA 350 MM	02
L 	PUXADOR REDONDO 75P	02
M 	COLA 12G	01

FERRAMENTAS (NÃO FORNECIDA)

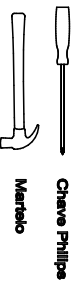

Novelbento
Rua: Joana Guindani Tonello
Barro Gonçalves, RS, Brasil
(54) 3454.7500
www.novelbento.com.br

PRÉ-MONTAGEM / PRE ARMADO / PRE-ASSEMBLE

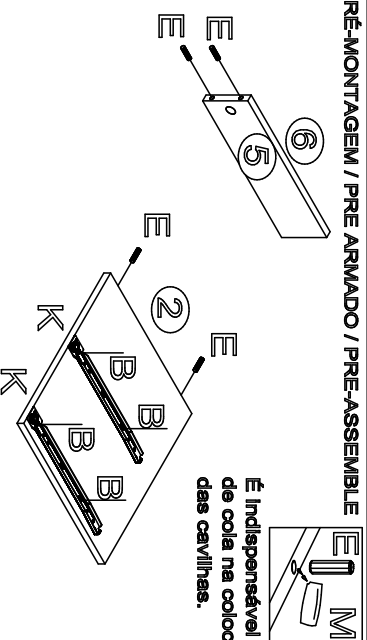

É indispensável o uso de cola na colocação das cavilhas.

1º MONTAGEM / MONTAJE / ASSEMBLY

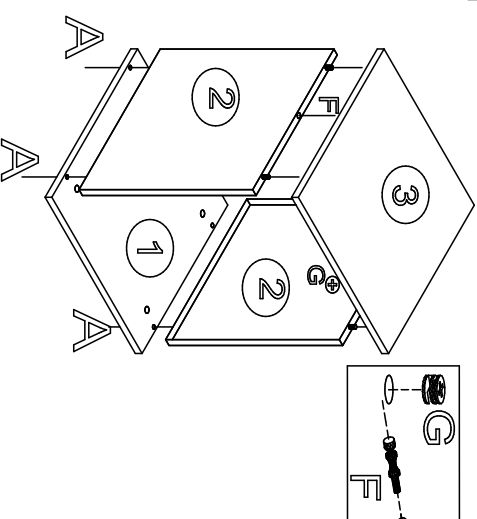

2º Usar cola nos pés / El uso de pegamento en los pies / Use glue on the feet

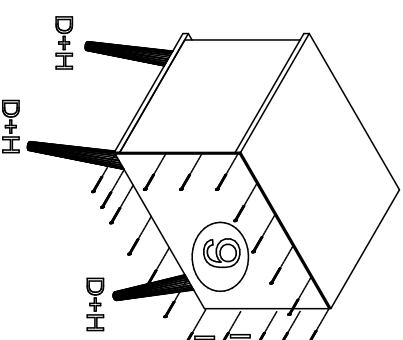

Montagem da gaveta / Cajón montaje/ Drawer assembly

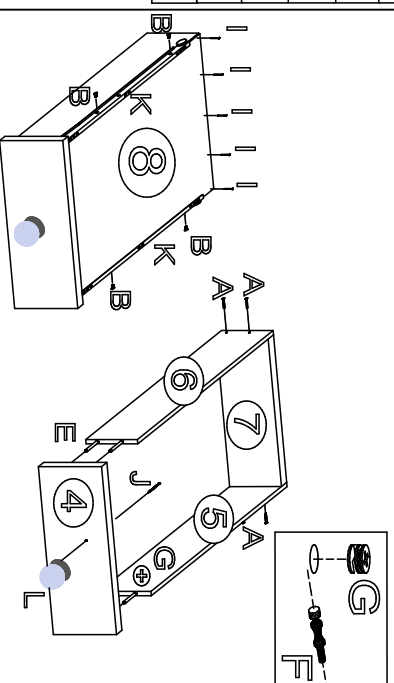

Aspecto Final / Final appearance

