

# BF - 3206



## Instruções de Montagem Assembly Instructions Instrucciones de Montaje

Acesse Vídeos de Montagens  
Access Mounting Videos  
Acceder a los Vídeos de Montaje  
[www.tecnomobili.ind.br](http://www.tecnomobili.ind.br)

**tecnomobili**

Estrada RSC 453, Km s/n° | Garibaldi | RS  
CEP: 95720-000 | Fone / Fax: 54.3464.2050

### Notas Especiais:

**01** - Examine completamente todas as peças do móvel antes de começar o trabalho.

**02** - Recomenda-se montar o móvel conforme este Manual de Montagem.

**03** - É de responsabilidade do montador seguir as instruções do Manual de Montagem, que são fundamentais para garantir a estrutura do móvel.

**04** - Para limpeza, utilizar somente pano úmido e sabão neutro.

### Special notes:

**01** - Check all parts of the unit thoroughly before starting work.

**02** - It is recommended to assemble the furniture according to this Installation Manual.

**03** - It is the responsibility of the assembler to follow the instructions in the Assembly Manual, which are essential to ensure the structure of the furniture.

**04** - For cleaning use only damp cloth and neutral soap.

### Notas especiales:

**01** - Examine completamente todas las piezas del mueble antes de iniciar el trabajo.

**02** - Se recomienda montar el mueble conforme el Manual de Ensamblaje.

**03** - Es de responsabilidad del montador seguir las instrucciones del Manual de Ensamblaje, que son fundamentales para garantizar la estructura del mueble.

**04** - Para limpieza solamente usar trapo húmedo y jabón neutro.





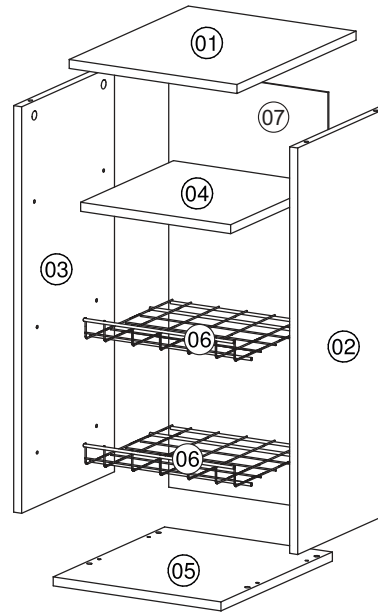

### Guarante certificate:

The guarantee of products manufactured by Móveis Videira LTDA covers any defects / manufacturing defects, within the period established by the Consumer Protection Code, in its Article 26, II, which provides for a legal guarantee of ninety (90) days.

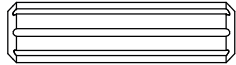
### Lista de Peças / List of pieces / Lista de piezas

CÓD	DESCRIÇÃO	DESCRIPTION	DESCRIPCIÓN	QTD	RAW MATERIAL	DIMENSION
01	Tampo	Top	Tapa	1	MDP 15mm	313x385x15
02	Lateral Direita	Right Side	Lateral Derecha	1	MDP 15mm	680x300x15
03	Lateral Esquerda	Left Side	Lateral Izquierda	1	MDP 15mm	680x300x15
04	Prateleira	Shelf	Estante	1	MDP 15mm	280x300x15
05	Base	Base	Base	1	MDP 15mm	313x360x15
06	Cesto	Basket	Cesto	2		280x285x39
07	Costa	Back	Revés	1	Capa Dura 3mm	700x297x3

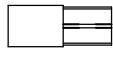

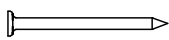
REF	DESCRIPTION	QTD
A	 8x30mm	04
B	 3,5x40mm CC	04
C	 5,0x40mm CC	04
D	 34x7mm Parafuso minifix	04
E	 15x12mm Tambor minifix	04
F	 Suporte para Prateleira 5x8 c/ Estria 14x8x5mm	04
G	 50x40mm Sapata	04
H	 22x3mm	16

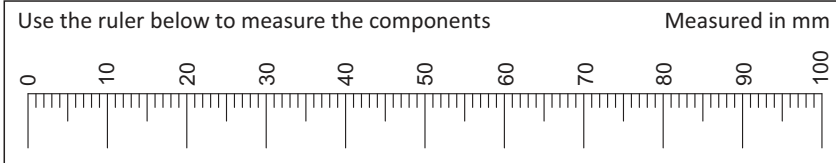

Review: 01  
Date:19/02/2018

### Ferramentas | Tools | Herramientas

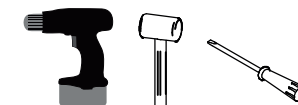

45 min.

