

MANUAL DE MONTAGEM

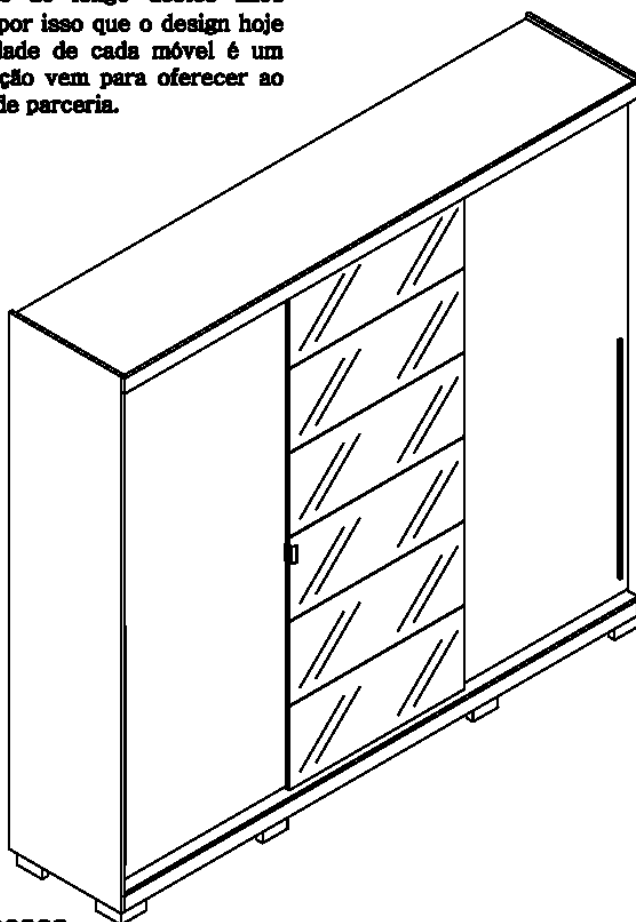









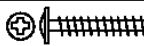
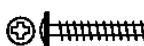
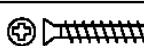
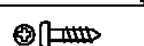
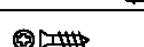

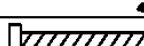
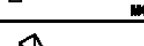

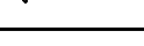

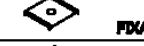













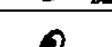

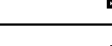

Parabéns, você acaba de adquirir um produto Kappesberg!

A Kappesberg é uma marca que cresceu e se desenvolveu com a população brasileira e de todos os países para onde exporta, e ao longo destes anos participa do seu dia-a-dia. É por isso que o design hoje é parte da sua vida, a qualidade de cada móvel é um compromisso diário e a inovação vem para oferecer ao cliente a confiança nessa grande parceria.



**Garantia de 06 (seis) meses,
por defeito de fabricação.**

COD. ASSISTENCIA	LEGENDA					
	PEÇAS	QTD	COMPR	LARG	ESPE	CAIXA
01	PORTA CENTRAL COM ESPELHOS	01	2117mm	835mm	15mm	B
02	PORTA ESQUERDA	01	2117mm	835mm	15mm	B
03	PORTA DIREITA	01	2117mm	835mm	15mm	B
04	LATERAL DIREITA	01	2240mm	540mm	15mm	A
05	LATERAL ESQUERDA	01	2240mm	540mm	15mm	A
06	CHAPÉU	01	2473mm	540mm	15mm	C
07	BASE	01	2473mm	540mm	15mm	C
08	BASE DO MALEIRO	01	2473mm	448mm	15mm	C
09	DIVISORIA MAIOR DIREITA	01	1764mm	448mm	15mm	D
10	DIVISORIA MAIOR ESQUERDA	01	1764mm	448mm	15mm	D
11	DIVISORIA MENOR	01	1169mm	448mm	15mm	A
12	TAMPO DE GAVETA ESQUERDO	01	790mm	448mm	15mm	D
13	TAMPO DE GAVETA DIREITO	01	790mm	448mm	15mm	D
14	PRATELEIRA MAIOR	01	863mm	448mm	15mm	D
15	PRATELEIRA DO CALCEIRO	01	863mm	256mm	15mm	C
16	PRATELEIRA MENOR	02	387mm	384mm	15mm	D
17	PILASTRA	02	350mm	96mm	15mm	A
18	FRENTE DE GAVETA	04	774mm	160mm	15mm	C
19	LATERAL DE GAVETA	08	400mm	120mm	15mm	D
20	CABECEIRA DE GAVETA	04	736mm	120mm	15mm	A
21	RODAFORRO	01	2505mm	64mm	15mm	C
22	RODAPÉ FRONTAL	01	2473mm	64mm	15mm	C
23	RODAPÉ TRASEIRO	01	2473mm	64mm	15mm	C
24	RODAPÉ INTERNO MENOR	02	488mm	64mm	15mm	A
25	RODAPÉ INTERNO MAIOR	01	863mm	114mm	15mm	C
26	COSTA ESTREITA	02	1782mm	437mm	3mm	A
27	COSTA LARGA	02	1782mm	807mm	3mm	B
28	COSTA DO MALEIRO	01	2493mm	367mm	3mm	C
29	FUNDO DE GAVETA	04	749mm	398mm	3mm	D

	CÓD.	FERRAGEM	QTDE.
A	2582	 PARAFUSO FLANGE ZINCADO BRANCO 4,0x40	50
A	4042	 PARAFUSO FLANGE ZINCADO PRETO 4,0x40	50
B	226	 PARAFUSO CHATO 4,0x40 RECOMENDADO	06
C	1828	 PARAFUSO PAINELA 3,8x14 ZINCADO BRANCO	12
D	4214	 PARAFUSO CHATO 3,8x14 ZINCADO BRANCO	129
E	5258	 PARAFUSO CHATO 4,0x40 RECOMENDADO	52
F	19730	 PARAFUSO MÁQUINA 100x8 PAINELA PHILIPS	04
G	18458	 SUPORTE TRIANGULAR PRETO	16
H	107	 PREGOS 10X10	125
I	1802	 CAVILHA 8x30MM	86
J	1925	 CAVILHA 8x30MM	06
K	1423	 FIXADOR DE COSTA	48
L	85	 "L" DE METAL	11
M	41	 OCLA BRANCA EM BORDA	01
N	4881	 ROLITE SEM REDELAJEM	03
O	4881	 ROLITE COM REDELAJEM	03
P	4881	 GUIA MEDICO	06
Q	1448	 SUPORTE OVALADO OBLONGO FURADO	06
R	4452	 BORDA DE SILICONE C/ LOBO "C"	10
S	10306	 PORTINHA 18X10 ORECHADA	04
T	5268	 CORREÇÃO 480MM (DE METAL, BRANCA)	04
U	889	 CANTONEIRA DE METAL	10
V	118	 SUPORTE PARA PRATELEIRA 6x6MM BORDA	08
W	2170	 PARAFUSO MINIFIX	06
X	2170	 TAMBORE MINIFIX	06
Y	8090	 TAMPA MINIFIX TICA ITALIA	06
Y	2347	 TAMPA MINIFIX BRANCO	06
Y	3329	 TAMPA MINIFIX TABACO	06
Z	19554	 CONJUNTO PE PLASTICO LIZ BRANCO	01
Z	19555	 CONJUNTO PE PLASTICO LIZ NOCE	01
AA	22197	 DIMENSIONADOR DE PORTAS 18x30 178CM BRANCO	04
AE	10277	 FIXADOR DE METAL 18X18 CROMADO 60MM	02
AF	35912	 ROLIÇO OBLONGO 1838 ALUMINIO FURADO 37,7	01
AG	35942	 ROLIÇO OBLONGO 1838 ALUMINIO FURADO 76,5	01
AH	35952	 ROLIÇO OBLONGO 1838 ALUMINIO FURADO 81,5	01
AI	9323	 TELHO DE ALUMINIO 3472MM	02
AJ	9324	 TELHO PLASTICO ALUMINIO 3472MM	02
AK	58	 kappesberg	01
AL	19697	 FIXADOR DE CINA 89 CROMADO	01
AM	22598	 PERFIL H BRANCO 170MM	01
AM	20066	 PERFIL H TICA ITALIA 170MM	01
AN	22572	 ESPELHO 82,7 X 34,9 (8MM)	06



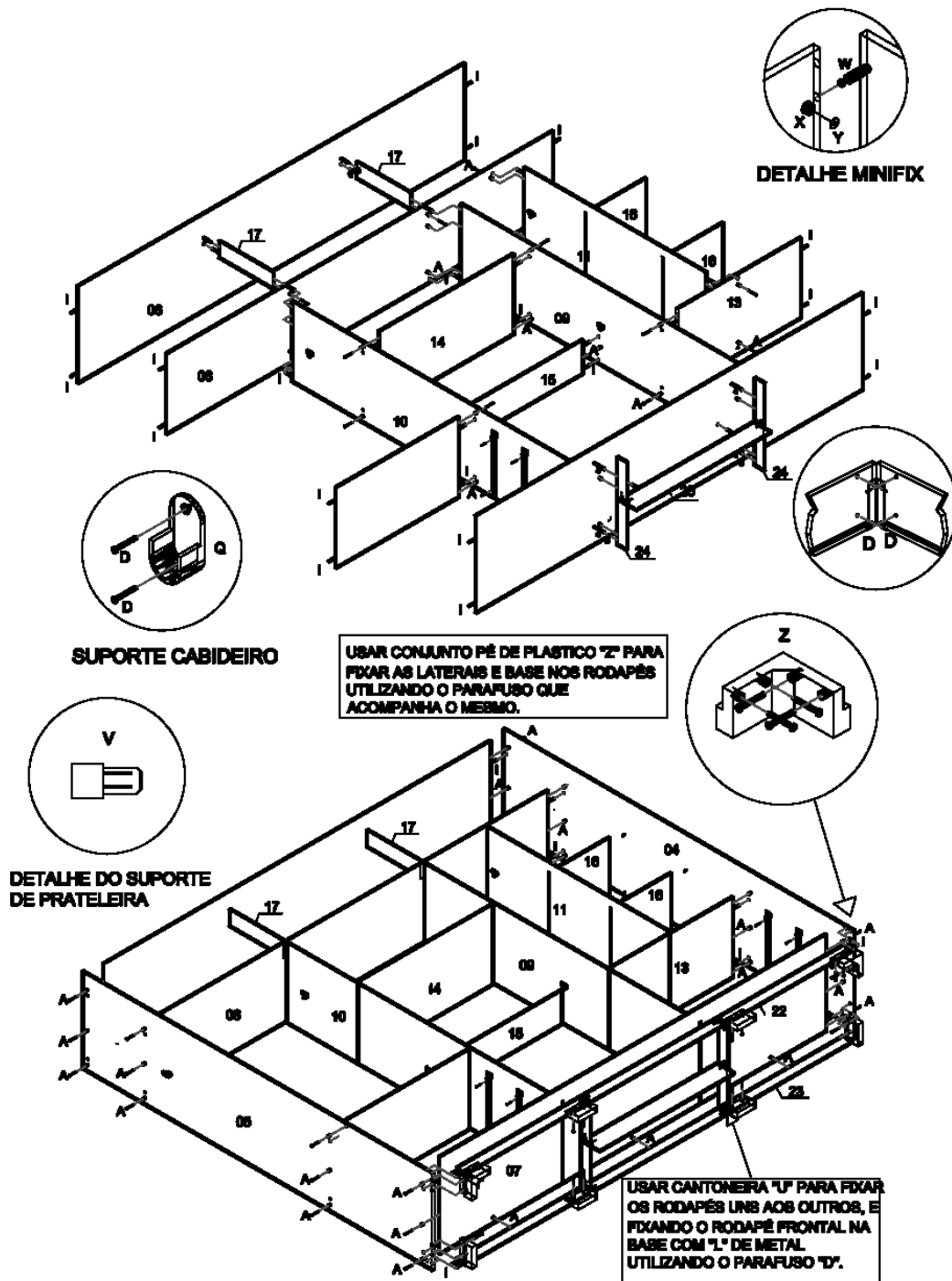

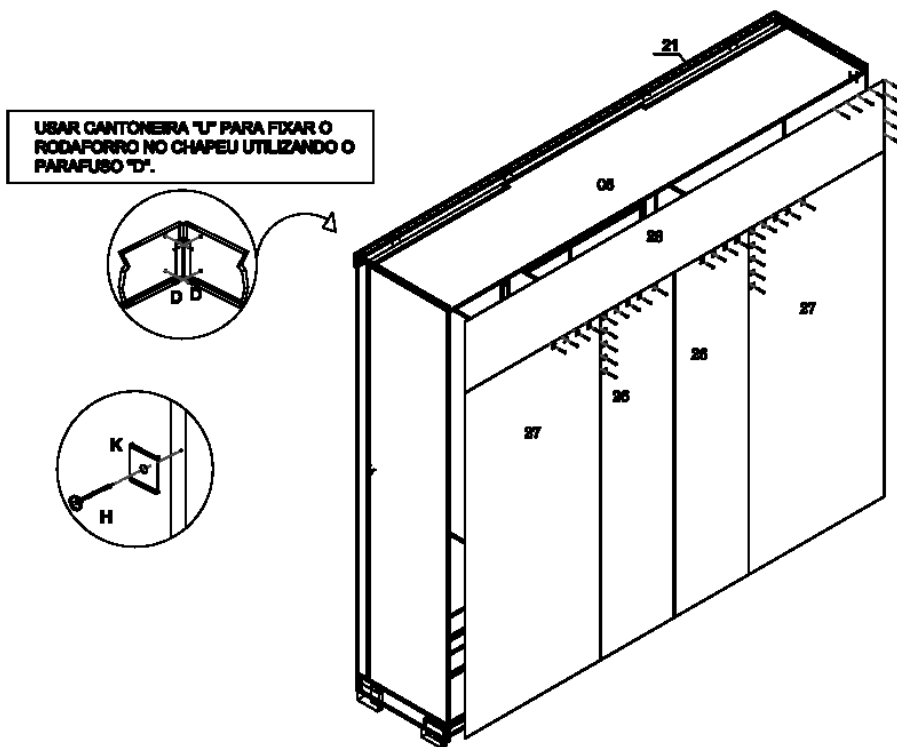
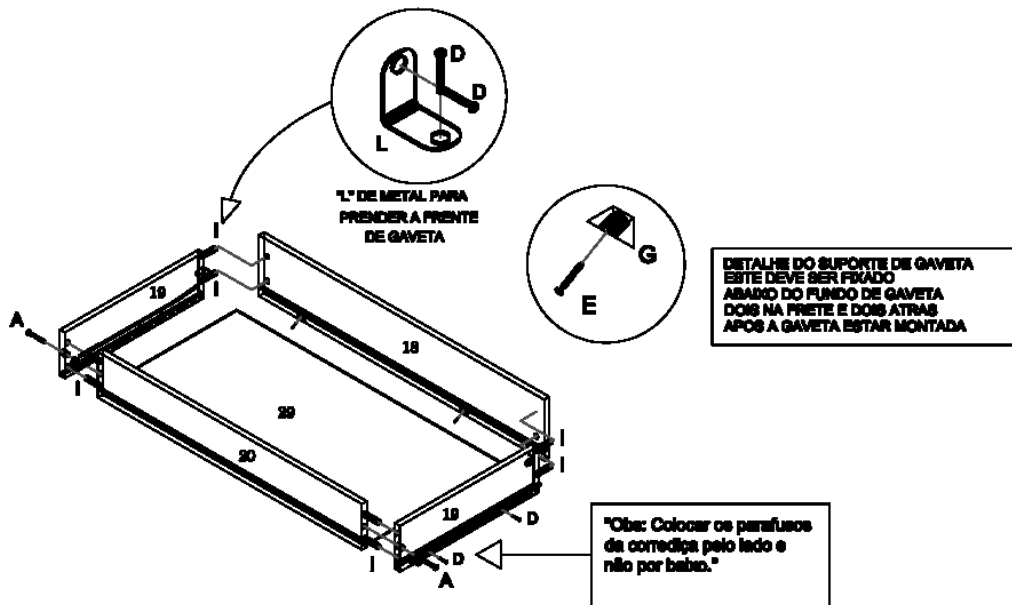

OS FIXADORES "AE" DAS PORTAS SEM FRISOS É FIXADO COM O PARAFUSO "T".

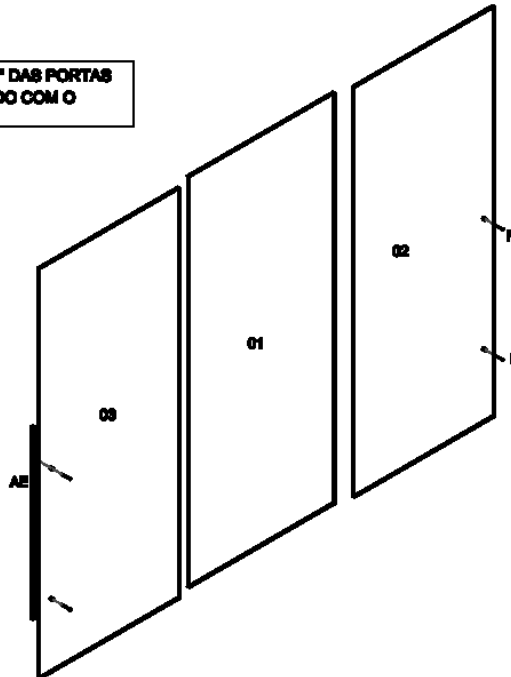

O FIXADOR "AL" DA PORTA COM FRISO É FIXADO COM O PARAFUSO "T".

Atenção leia as instruções



Para um bom funcionamento das portas de correr, siga as instruções a seguir:

1) Importante: colocar a porta em uma superfície reta (para que não aconteça de parafusar sua porta e empenar em um lugar com relevo).

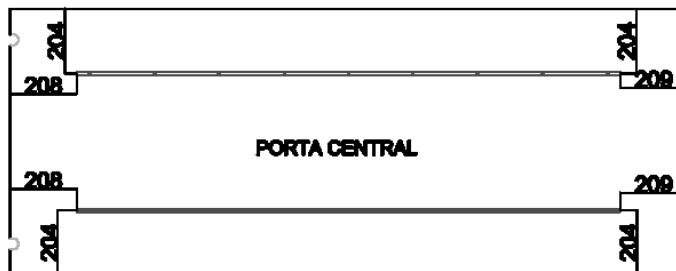

2) Posicione a barra de ferro na porta conforme o desenho ao lado.

3) Fixar a barra usando o parafuso "E".

4) OBS: Colocar todos parafusos "E" nas abas da barra de ferro.

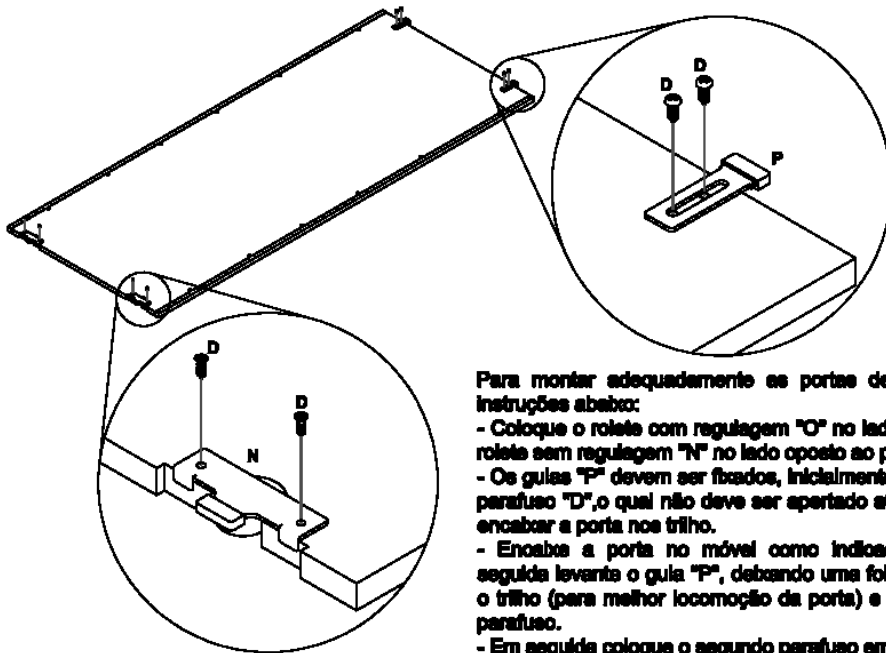

Para montar adequadamente as portas de correr, siga as instruções abaixo:

- Coloque o rolete com regulagem "O" no lado do puxador e o rolete sem regulagem "N" no lado oposto ao puxador.
- Os guias "P" devem ser fixados, inicialmente com apenas um parafuso "D", o qual não deve ser apertado até o fim, antes de encabar a porta no trilho.
- Encabe a porta no móvel como indicado abaixo e em seguida levanta o guia "P", deixando uma folga entre o guia e o trilho (para melhor locomoção da porta) e aperte o primeiro parafuso.
- Em seguida coloque o segundo parafuso em cada guia.

Atenção:

- Uma porta não deve bater no puxador da outra, para isso ajuste o batente contido no trilho superior.

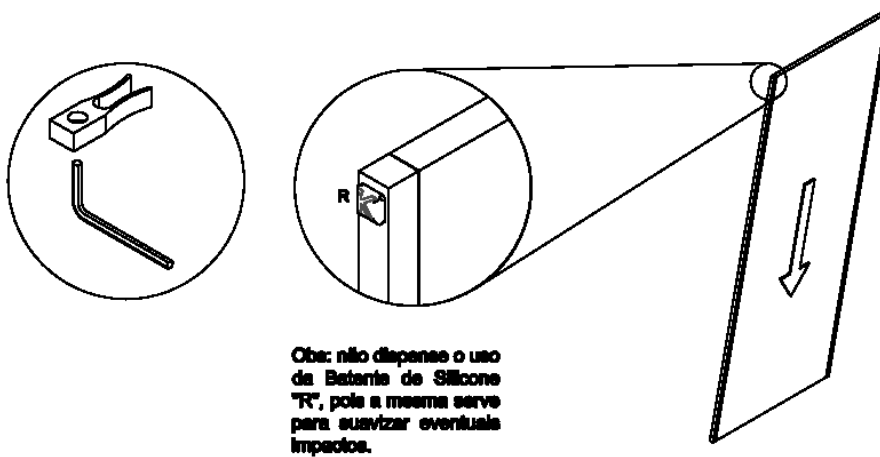

Obs: não dispense o uso da Bateria de Silicone "R", pois a mesma serve para suavizar eventuais impactos.

Atenção leia as instruções

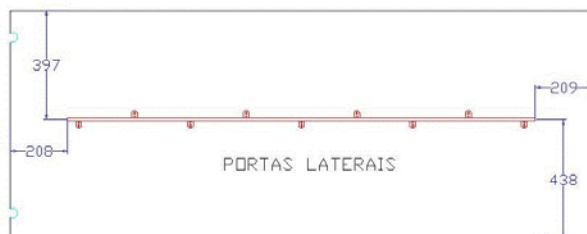

Para um bom funcionamento das portas de correr, siga as instruções a seguir:

1) Importante: colocar a porta em uma superfície reta (para que não aconteça de parafusar sua porta e empenar em um lugar com relevo).

2) Posicione a barra de ferro na porta conforme o desenho ao lado.

3) Fixar a barra usando o parafuso "D".

4) OBS: Colocar todos parafusos "D" nas abas da barra de ferro.

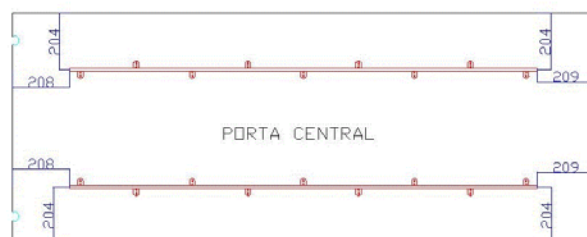

Atenção leia as instruções



Para um bom funcionamento das portas de correr, siga as instruções a seguir:

1) Importante: colocar a porta em uma superfície reta (para que não