

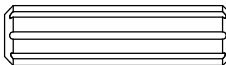

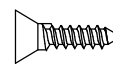

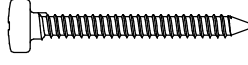

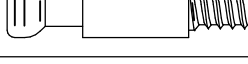

BL - 3301

Instruções de Montagem Instrucciones de Montaje

tecnobili

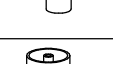
Estrada RSC 453, Km s/nº | Garibaldi | RS
CEP: 95720-000 | Fone / Fax: 54.3463.8508

REF	DESCRIÇÃO	QTD
A	 8x30mm	12
B	 3,5x14mm CC	16
C	 3,5x30mm CP	02
D	 3,5x40mm CC	08
E	 5x40mm CC	04
F	 Minifix	08
G	 Tambor Minifix	08
H	 Dobradiça	04
I	 Pregos 10x10	30
J	 Puxador Ponto	02
L	 Sapata	04
M	 Tapa Furo	02

Lista de peças / Lista de piezas

CÓD	DESCRIÇÃO	QTD	M. PRIMA	DIMENSÕES
01	Tampo	1	MDP 15mm	610 x 385 x 15
02	Tampo Intermediário	1	MDP 15mm	610 x 385 x 15
03	Prateleira	1	MDP 15mm	578 x 300 x 15
04	Base	1	MDP 15mm	610 x 385 x 15
05	Lateral Superior Esquerda	1	MDP 15mm	385 x 255 x 15
06	Lateral Superior Direita	1	MDP 15mm	385 x 255 x 15
07	Lateral Esquerda	1	MDP 15mm	680 x 300 x 15
08	Lateral Direita	1	MDP 15mm	680 x 300 x 15
09	Porta	2	MDP 15mm	385 x 291 x 15
10	Costa Superior	1	Chapa Dura 3mm	597 x 120 x 3
11	Costa Inferior	1	Chapa Dura 3mm	597 x 405 x 3

Notas especiais:

01 - Examine completamente todas as peças do móvel antes de iniciar o trabalho.

02 - Recomenda-se montar o móvel conforme este Manual de Montagem.

03 - É de responsabilidade do montador seguir as instruções do Manual de Montagem, que são fundamentais para garantir a estrutura do móvel.

04 - Para limpeza utilizar somente pano úmido e sabão neutro.

Notas especiales:

01 - Examine completamente todas las piezas del mueble antes de iniciar el trabajo.

02 - Se recomienda montar el mueble conforme el Manual de Ensamblaje.

03 - Es de responsabilidad del montador seguir las instrucciones del Manual de Ensamblaje, que son fundamentales para garantizar la estructura del mueble.

04 - Para limpieza solamente usar trapo húmedo y jabón neutro.

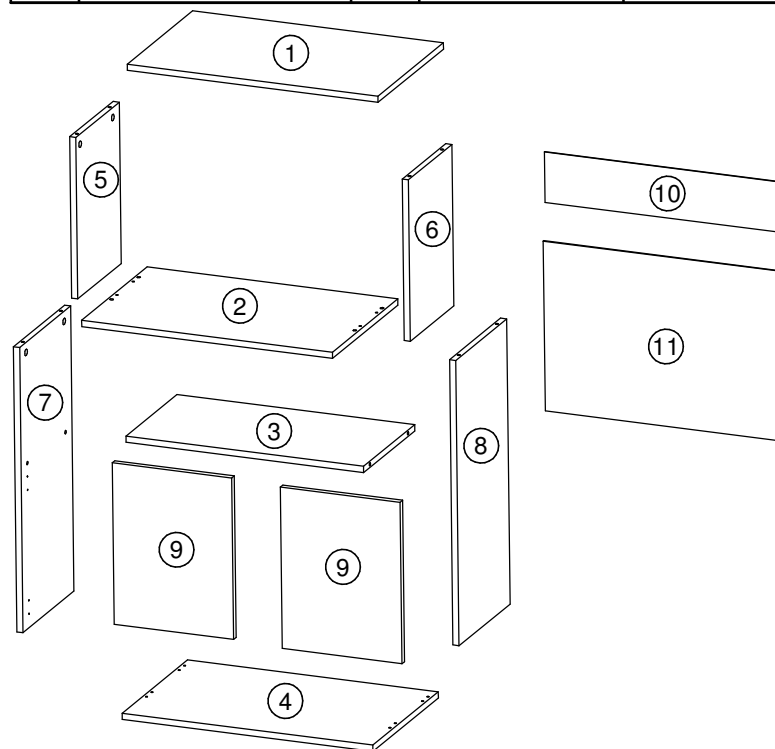

Ferramentas | Herramientas

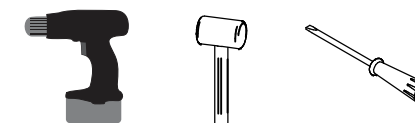

30 min.



Revisão: 03
Data: 31/07/2012

