

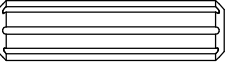

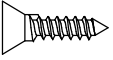

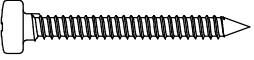

BL - 3300

Instruções de Montagem Instrucciones de Montaje

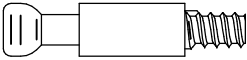
REF	DESCRIÇÃO	QTD
A	 8x30mm	04
B	 3,5x14mm CC	32
C	 3,5x30mm CP	02
D	 3,5x35mm CC	04
E		04
F		04
G		04
H	 Prego 10x10	20
I		02
J		04
L	 Suporte 6x8	06
M	 Perfil "I" 680mm	01

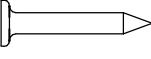
Lista de peças / Lista de piezas

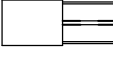
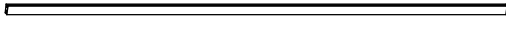
CÓD	DESCRIÇÃO	QTD	M. PRIMA	DIMENSÕES
01	Tampo	1	MDP 15mm	610 x 410 x 15
02	Base	1	MDP 15mm	610 x 410 x 15
03	Lateral Esquerda	1	MDP 15mm	680 x 360 x 15
04	Lateral Direita	1	MDP 15mm	680 x 360 x 15
05	Prateleira	1	MDP 15mm	578 x 250 x 15
06	Porta	2	MDP 15mm	672 x 291 x 15
07	Costa	2	Chapa Dura 3mm	700 x 297 x 3

Notas especiais:

- 01** - Examine completamente todas as peças do móvel antes de iniciar o trabalho.
- 02** - Recomenda-se montar o móvel conforme este Manual de Montagem.
- 03** - É de responsabilidade do montador seguir as instruções do Manual de Montagem, que são fundamentais para garantir a estrutura do móvel.
- 04** - Para limpeza utilizar somente pano úmido e sabão neutro.

Notas especiales:

- 01** - Examine completamente todas las piezas del mueble antes de iniciar el trabajo.
- 02** - Se recomienda montar el mueble conforme el Manual de Ensamblaje.
- 03** - Es de responsabilidad del montador seguir las instrucciones del Manual de Ensamblaje, que son fundamentales para garantizar la estructura del mueble.
- 04** - Para limpieza solamente usar trapo húmedo y jabón neutro.

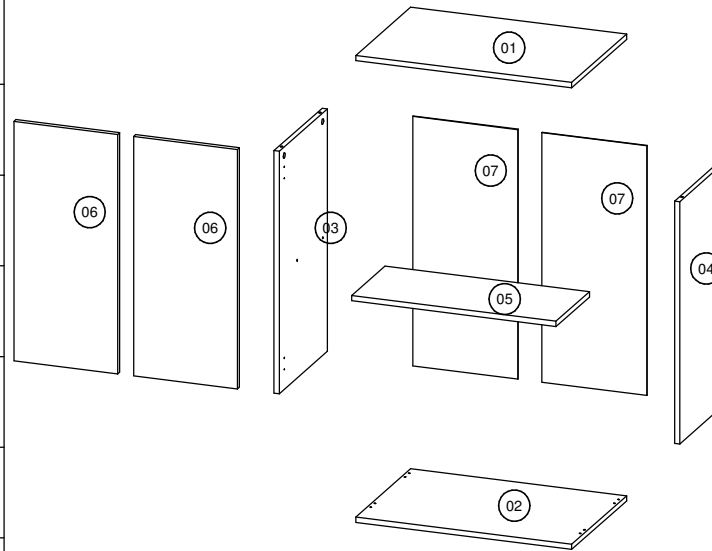

Ferramentas | Herramientas

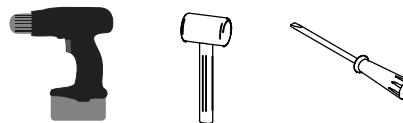

30 min.



Revisão: 05
Data: 31/07/2012

