

ME 4101

Instruções de Montagem Instrucciones de Montaje

Notas especiais:











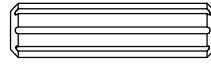





- 01** - Examine completamente todas as peças do móvel antes de iniciar o trabalho.
02 - Recomenda-se montar o móvel conforme este Manual de Montagem.
03 - É de responsabilidade do montador seguir as instruções do Manual de Montagem, que são fundamentais para garantir a estrutura do móvel.
04 - Para limpeza utilizar somente pano úmido e sabão neutro.

Notas especiales:

- 01** - Examine completamente todas las piezas del mueble antes de iniciar el trabajo.
02 - Se recomienda montar el mueble conforme el Manual de Esamblaje.
03 - Es de responsabilidad del montador seguir las instrucciones del Manual de Ensamblaje, que son fundamentales para garantizar la estructura del mueble.
04 - Para limpieza solamente usar trapo húmedo y jabón neutro.

Lista de peças / Lista de piezas

CÓD	DESCRIÇÃO	QTD	M. PRIMA	DIMENSÕES
01	Tampo	1	MDP 15mm	1360 x 451 x 15mm
02	Lateral	1	MDP 15mm	725 x 450 x 15mm
03	Divisão	1	MDP 15mm	725 x 450 x 15mm
04	Lateral Gaveteiro	1	MDP 15mm	725 x 450 x 15mm
05	Rodapé	1	MDP 15mm	320 x 70 x 15mm
06	Costa	1	MDP 15mm	993 x 300 x 15mm
07	Costa Menor	1	MDP 15mm	725 x 320 x 15mm
08	Frente Gaveta	3	MDP 15mm	204 x 300 x 15mm
09	Lateral Gaveta	6	MDP 15mm	300 x 140 x 15mm
10	Costa Gaveta	3	MDP 15mm	140 x 265 x 15mm
11	Fundo Gaveta	3	Chapa Dura 3mm	310 x 245 x 3mm
12	Travessa	1	MDP 15mm	1361 x 45 x 15mm
13	Travessa Direita	1	MPD 15mm	741 x 45 x 15mm
14	Travessa Esquerda	1	MDP 15mm	741 x 45 x 15mm
15	Tampo Menor	1	MDP 15mm	680 x 301 x 15mm
16	Lateral Menor	1	MDP 15mm	679 x 300 x 15mm
17	Costa Menor Bancada	1	MDP 15mm	664 x 255 x 15mm
18	Travessa Esquerda Menor	1	MDP 15mm	694 x 45 x 15
19	Travessa Direita Menor	1	MDP 15mm	694 x 45 x 15

REF	DESCRIÇÃO	QTD
A	 Cavilha 8 x 30mm	14
B	 Parafuso 3,5 x 14mm CF	32
C	 Parafuso 3,5 x 16 CC	54
D	 Parafuso 3,5 x 30CP	03
E	 Parafuso minifix	29
F	 Tambor minifix	35
G	 Minifix haste dupla	03
H	 Suporte angular	16
I	 Cantoneira	05
J	 Distanciador de corredeira	06
K	 Prego 10 x 10mm	08
L	 Sapata deslizadora	08
M	 Corredeira 350mm	03
N	 Puxador	03
O	 Tapa Furo	04
P	 Suporte Z	02

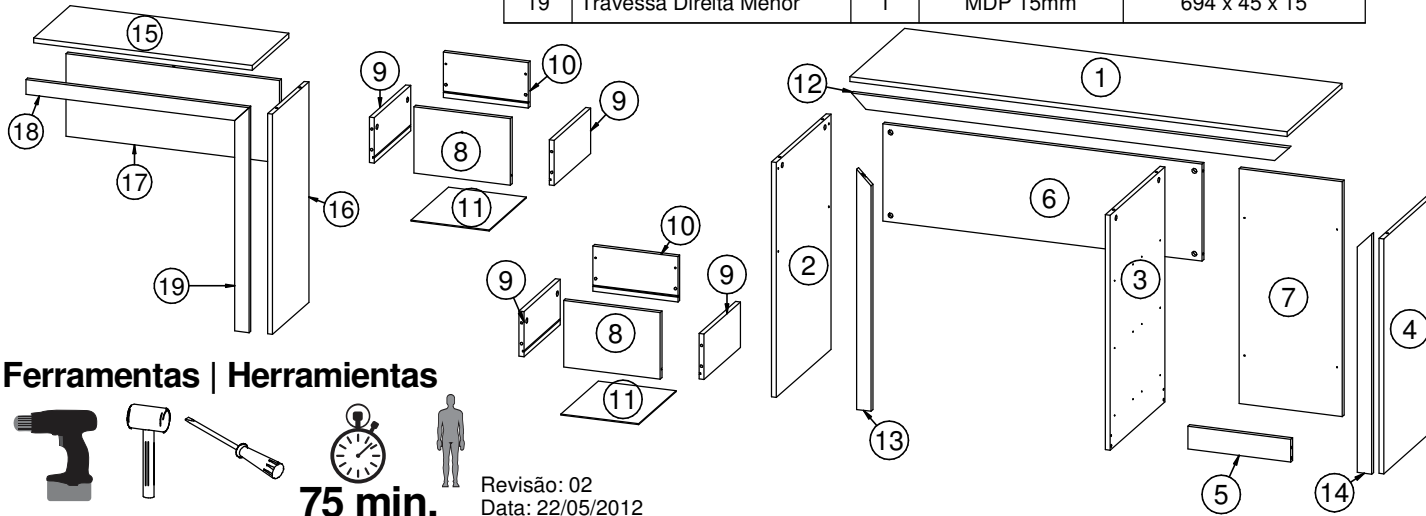
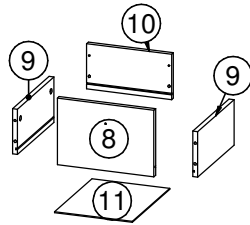

Ferramentas | Herramientas



75 min.

Revisão: 02
Data: 22/05/2012

