

ME-4112

Instruções de Montagem Instrucciones de Montaje

tecnobili

Estrada RSC 453, Km s/nº | Garibaldi | RS
CEP: 95720-000 | Fone / Fax: 54.3463.8508

Notas especiais:

- 01** - Examine completamente todas as peças do móvel antes de iniciar o trabalho.
- 02** - Recomenda-se montar o móvel conforme este Manual de Montagem.
- 03** - É de responsabilidade do montador seguir as instruções do Manual de Montagem, que são fundamentais para garantir a estrutura do móvel.
- 04** - Para limpeza utilizar somente pano úmido e sabão neutro.

Notas especiales:

- 01** - Examine completamente todas las piezas del mueble antes de iniciar el trabajo.
- 02** - Se recomienda montar el mueble conforme el Manual de Esamblaje.
- 03** - Es de responsabilidad del montador seguir las instrucciones del Manual de Esamblaje, que son fundamentales para garantizar la estructura del mueble.
- 04** - Para limpieza solamente usar trapo húmedo y jabón neutro.

Data: 25/01/2014

Revisão: 03

Ferramentas | Herramientas

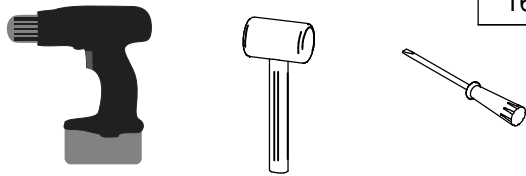









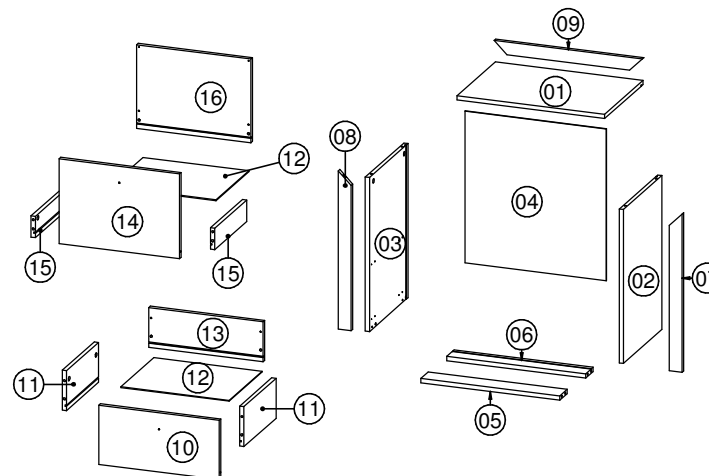

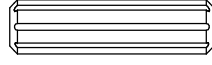
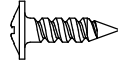
30 min.

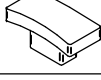

Lista de peças / Lista de piezas

CÓD	DESCRIÇÃO	QTD	M. PRIMA
01	Tampo	1	MDP 15mm
02	Lateral Direita	1	MDP 15mm
03	Lateral Esquerda	1	MDP 15mm
04	Costa	1	Chapa Dura 3mm
05	Rodapé Dianteiro	1	MDP 15mm
06	Rodapé Traseiro	1	MDP 15mm
07	Travessa Direita	1	MPD 15mm
08	Travessa Esquerda	1	MDP 15mm
09	Travessa Frontal	1	MDP 15mm
10	Frente Gaveta	1	MDP 15mm
11	Lateral Gaveta Maior	2	MDP 15mm
12	Fundo Gaveta	2	Chapa Dura 3mm
13	Costa Gaveta	1	MDP 15mm
14	Frente Gaveta Maior	1	MDP 15mm
15	Lateral Gaveta	2	MDP 15mm
16	Costa Gaveta Maior	1	MDP 15mm

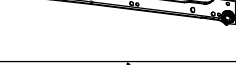

REF	DESCRIÇÃO	QTD
A	 Cavilha 8 x 30mm	12
B	 Parafuso 3,5 x 14mm CF	20
C	 Parafuso 3,5 x 16 CC	44
D	 Parafuso 3,5 x 30CP	02
E	 Parafuso minifix	16
F	 Tambor minifix	20
G	 Minifix haste dupla	02
H	 Suporte angular	06
I	 Puxador Ponto	02
J	 Distanciador de correção	08
K	 Rodízio	04
L	 Correção 300mm	02
M	 Aramado	02

