

ME-4109

Instruções de Montagem Instrucciones de Montaje

Notas especiais:







- 01** - Examine completamente todas as peças do móvel antes de iniciar o trabalho.
02 - Recomenda-se montar o móvel conforme este Manual de Montagem.
03 - É de responsabilidade do montador seguir as instruções do Manual de Montagem, que são fundamentais para garantir a estrutura do móvel.
04 - Para limpeza utilizar somente pano úmido e sabão neutro.

Notas especiales:

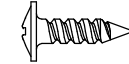
- 01** - Examine completamente todas las piezas del mueble antes de iniciar el trabajo.
02 - Se recomienda montar el mueble conforme el Manual de Ensamblaje.
03 - Es de responsabilidad del montador seguir las instrucciones del Manual de Ensamblaje, que son fundamentales para garantizar la estructura del mueble.
04 - Para limpieza solamente usar trapo húmedo y jabón neutro.

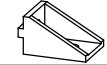
Lista de peças / Lista de piezas

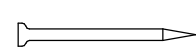
CÓD	DESCRIÇÃO	QTD	M. PRIMA	DIMENSÕES
01	Tampo	1	MDP 15mm	1630 x 570 x 15mm
02	Lateral	2	MDP 15mm	725 x 569 x 15mm
03	Costa	1	MDP 15mm	1599 x 360 x 15mm
04	Travessa Frontal	2	MDP 15mm	1631 x 45 x 15mm
05	Travessa Direita	2	MDP 15mm	741 x 45 x 15mm
06	Travessa Esquerda	2	MDP 15mm	741 x 45 x 15mm

REF	DESCRIÇÃO	QTD
A	 Minifix	10
B	 Parafuso 3,5 x 14mm CF	40
C	 Tambor Minifix	18
D	 Minifix haste dupla	04
E	 Suporte angular	20
F	 Sapata	04
G	 Prego 10 x 10CC	04
H	 Adesivo Tapafuro	10

Ferramentas | Herramientas

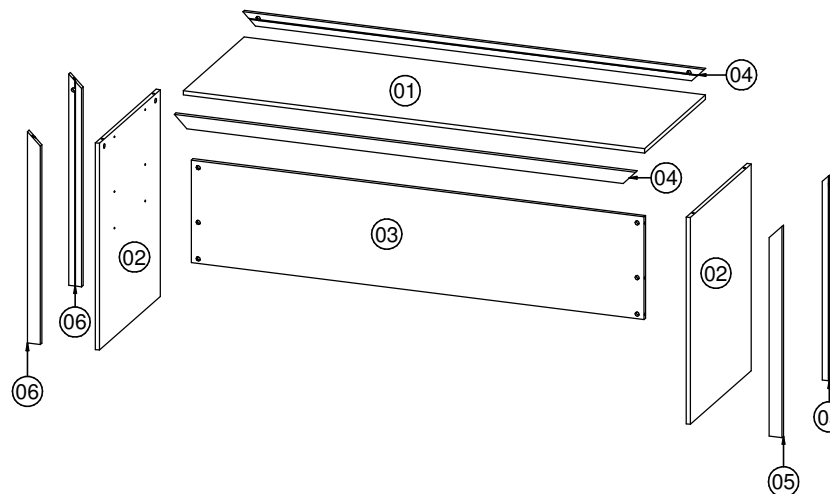
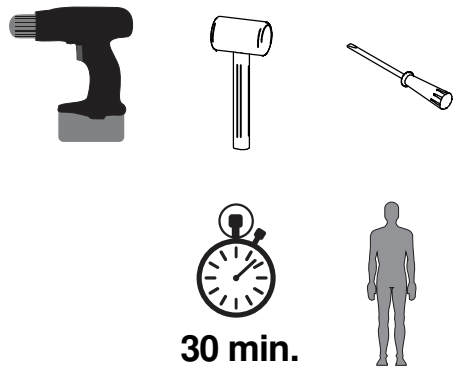

Data: 30/09/2013
Revisão: 00

